

BUYERS' GUIDE

2021

Fasteners & Tools



_AD.[287]

310EXPRESS

☉ Security Screws, Tamper-proof Screws, Miniature Precision Screws, 310Tamper (Security, Tamper Resistant, Anti-theft Fasteners) ☉ Export division of SAIMA CORPORATION which has been the largest security screw manufacturer since 1952 in Japan. Export even 1 single piece from stock. Carry many kinds of unique fasteners that are hard to find in your country. Staff 50(including group office). Capital JPY10,000,000. Quick shipment from stock. Certs. such as Material, Inspection, RoHS ... etc.

☉ www.310ex.com
☉ info@310ex.com



_AD.[165]

A & M PRODUCTS

☉ Special Nuts, Spacers, Weld Nuts, Cold Forged Nuts, Automotive Nuts, Flange Nuts, Bushing, Prevailing Torque Nuts, Nut and Washer Assembly, Double End Stud, Special Square & Hex Nut, Nylon Flange Nuts ☉ A&M is specialized in special fasteners for automotive & industry sectors. With more than 20 years of production experience in Taiwan, we supply our goods worldwide through local channels. As a IATF16949 certified company, quality is our top priority.

☉ www.amproducts.com.tw
☉ sales@amproducts.com.tw
奈瑞興業有限公司



_AD.[280]

ABC FASTENERS

☉ Drop-in Anchors, Expansion Anchors, Wire Anchors, Sleeve Anchors, Ceiling Anchors, Nylon Nail Anchors, Nail In Anchors, Anchors, Hammer Drive Anchors, Anchor Bolts, Wedge Anchors, Metal Frame Anchor, Tie Wire Anchor, Bolt Anchor, Heavy Duty Anchor, Nylon Frame Anchor
☉ We are able to provide various kinds of anchors. Our main export regions are South America, Europe, South East Asia, such as: Chile, Colombia, Brazil, Italy, Singapore...

☉ www.abc-fasteners.com
☉ budifast@yahoo.com
寧波聯欣標準件有限公司



ABS METAL INDUSTRY

☉ Flanged Head Bolts, Roofing Bolts, Roofing Screws, Tapitite Screws, PT Screws, Automotive Screws, Farmer Screws, Construction Fasteners, Furniture Screws, Customized Special Screws / Bolts, Special Screws, Chipboard Screws
☉ ABS METAL Industry Corp. is an ISO-9001-2015 Cert. company and supplies qualified fasteners conforming to different standards - SAE, ASTM, ISO and DIN. Please contact us for more information.

☉ www.abs-metal.com.tw
☉ abs.metal@msa.hinet.net
得鈺企業股份有限公司





_AD.[275]

ADVANCE FASTECH INDUSTRIAL

☎ Aerospace Screws, Aircraft Nuts, Automotive & Motorcycle Special Screws / Bolts, Construction Fasteners, Weld Nuts, Wheel Nuts, Aluminum Bolts, Stainless Steel Bolts, Special Bolts, Long Bolts, Multi-stroke Rivets
 ☎ Breaking traditional myth of technology to create trilateral gains
 ☎ www.fastener-world.com/en/supplier/advance-fastech
 ☎ johnsonijsu@gmail.com
 毓盛科技工業有限公司



_AD.[147]

AEH FASTEN INDUSTRIES

☎ Clevis Pins, Dowel Pins, Machine Bolts, T-head or T-slot Bolts, Weld Bolts (studs), Hollow Rivets, Internally Threaded Rivets, Miniature Rivets, Shoulder Rivets, Security Screws, Tubular Rivets, Multi-stroke Rivets ☎ Established in: April, 1980 /Capital: \$500,000 USD / Business types: Metal Rivets, Nuts, Tapped Rivets, Pins, Eyelets, Multi-Stage Rivets, Semi-Tubular Rivets and other customized products in most materials. / Market: Worldwide
 ☎ www.aeh.com.tw
 ☎ sales@ae.com.tw
 鉅昌五金有限公司



_AD.[066]

AIMREACH ENTERPRISES

☎ Stainless Steel, Flanged Head Bolts, Hexagon Head Bolts, Chipboard Screws, Drywall Screws, Wood Screws, Self-drilling Screws, PVC Screws, Automotive Screws, Roofing Screws, Tapping Screws, Bi-metal Screws ☎ As Aimreach started as a trading company since 1991, after 5-year hard work, we also established a small sized self-drilling screws factory. In addition to the production of self-drilling screws, we also offer extreme quality of drywall screws and roofing screws.
 ☎ www.aimreachfasteners.com
 ☎ sales@aimreachfasteners.com
 盛融企業有限公司



_AD.[035]

ALEX SCREW INDUSTRIAL

☎ Chipboard Screws, Drywall Screws, Plastite Screws, Machine Screws, Roofing Screws, Concrete Screws, Self-Tapping Screws, Self-drilling Screws, Taptite Screws, Wood Screws, Collated Screws, Thread Forming Screws ☎ Alex Screw was founded in 1983, located in Gangshan Ben-Chou Industrial Park, Kaohsiung, Taiwan. Manufacturing & exporting different kinds of Steel Screws, Stainless Steel Screws. Range from 2.0 mm to 8.0 mm, length up to 300 mm.
 ☎ www.alexscrow.com.tw
 ☎ anne-chenrg@alexscrow.com.tw
 禾億五金有限公司



_AD.[138]

ALISHAN INTERNATIONAL GROUP

☎ U Bolts, Aluminum Carabiners, Automotive & Motorcycle Special Screws / Bolts, Eye Screws, Wing Nuts, Special Nuts, Special Rivets, Hex Keys, Bits, Screwdrivers, Safety Hooks, Turning Parts ☎ We are a professional manufacturer which is specialized in wire, forged & and die-casting parts, and fasteners, mainly for cargo ships, construction, machinery, and industrial purposes. We supply screws, nuts, and other industrial parts in customized sizes and specifications.
 ☎ www.shun-den.com.tw
 ☎ shunden@seed.net.tw
 奧立康國際股份有限公司



_AD.[277]

ALLMATE FASTENER

☎ Dowel Pins, Grooved Pins, Spring Pins, Flange Screws, Slotted Set Screws, Socket Head Cap Screws, Socket Set Screws ☎ Manufacturer of Socket Cap Screw, Socket Sems Screw, 12 Point Flange Screw, Slotted Headless Set Screw, Spring, Dowel, Grooved Pin.
 ☎ www.fastener-world.com/en/supplier/allmate
 ☎ allfast@ms17.hinet.net
 晟崑企業有限公司





ALLOY & STAINLESS FASTENERS
Industrial Bolting

Bolts · Nuts · Studs · Sockets · Washers · Bent Bolts

Special Metals and Alloys	10,000 Ton Inventory
Over 150 Material Grades	Over 300 Machines
Over 25 Coatings and Platings	Future Stock Programs
Serving Distributors Worldwide	We Service All Quantities



_AD.[231]

ALLOY & STAINLESS FAST.

☎ All Kinds of Nuts, Metric Bolts, Studs, Sockets, Washers, Special Parts ☎ Alloy and Stainless Fasteners, uses its more than 40 years of experience to continue leading the manufacturing and distributing of fasteners, by providing services to domestic and international markets with our in-house forging, machining, threading, bending, and metal bar production capabilities. Our company services the oil, gas, chemical, and petrochemical industries with over 10,000 tons of inventory in our manufacturing facilities.

☎ www.GoASF.com
☎ Global@GoASF.com



_AD.[181]

AL-PRO METALS

☎ Auto Parts Screws, Concrete Screws, Furniture Screws, Micro Screws, Self drilling Screws, Self Tapping Screws, SEMS Screws, Special Bolts, Knurled Nuts, Hex Flange Nuts, Hex Jam Nuts (Brass Nuts), Special Nuts, Square Nuts, Washers, Spring Washers, SUS Washers, Magnet Sleeves ☎ AL-Pro was established in 1994. The leading manufacturer of various kinds of fasteners, screws, nuts, bolts and washers in stainless steel, carbon steel, brass and aluminium alloy.

☎ www.alpro-metals.com
☎ alpro.metals@msa.hinet.net
錦茂金屬有限公司



_AD.[265]

ALZIN COATING SYSTEMS

☎ Surface Treatment and Related Equipment Alzin Coating Systems ☎ Service for corrosion resistant fasteners and parts including construction screws, self-drilling screws, self-tapping screws, slotted screws, screws with washers, special screws, high-tensile bolts and hardware. MECHANICAL ZINC ALLOY COATING 1. Use of automatic mechanical plating system 2. Use of the original purest zinc alloy powder 3. A highly compacted layer of... Alzin Coating Systems

☎ www.alzin.com.tw
☎ alzin@alzin.com.tw
添福德股份有限公司



_AD.[086]

AMBROVIT S.P.A.

☎ Chipboard Screws, Hexagon Nuts, Self-drilling Screws, Machine Screws, Wood Screws, Taptite Screws, PVC Screws, Self-Tapping Screws, Drywall Screws, Blind Rivets, Concrete Screws, Hexagon Head Bolts ☎ Leading Italian company whose priority is the constant technological development to promptly answer the requests of the market, with faster deliveries also thanks to a stock in prompt delivery which is unique in Europe. Products are constantly tested with the most innovative technologies, in order to ensure the best quality.

☎ www.ambrovit.com
☎ sales@ambrovit.com



_AD.[127]

AMPLE LONG INDUSTRY

☎ Hollow Rivets, Shoulder Rivets, Drive Rivets, Semi-tubular Rivets, Button Rivets, Male/female Screws, Male/Female Rivets, Button ☎ Ample Long Industry Co., Ltd. founded in 1980, is the most respected rivet manufacturer in Taiwan. From the beginning, Ample Long Co., has specialized in Rivets and due to our insistence in keeping the quality of our products at a premium, prompt delivery and good service, we have owned the satisfaction and trust of our clients.

☎ www.amplelong.com.tw
☎ amplelon@ms22.hinet.net
寬長工業有限公司



_AD.[454]

ANCHOR FASTENERS INDUSTRIAL

☎ Drop-in Anchors, Expansion Anchors, Wire Anchors, Blind Nuts / Rivet Nuts, Sleeve Anchors, Anchor Bolts, Automotive Parts, Fixing, Anchor Nuts, Power Blind Rivets, Clinching Fasteners, Anchor Thread, Anchor Stud, Jack Nuts, Split Nuts, Rubber Nuts, Wheel Hub Bolts, Ball Studs & Cases... ☎ For more than 30 years since 1986, Anchor has been dedicated to manufacturing high quality fasteners for the construction, automotive and electronic industries.

☎ www.anchorfast.com.tw
☎ sales@anchorfast.com.tw
安拓實業股份有限公司





_AD.[241]

APEX FASTENER INTERNATIONAL

☉ Automotive & Motorcycle Special Screws / Bolts, Automotive Screws, Double-head Screws / Bolts, Lock Nuts, Flange Nuts, Self-locking Nuts, Weld Nuts, Special Bolts, Automotive Nuts, Prevailing Torque Nuts, All Kinds of Nuts ☉ Young and energetic as APEX FASTENER is actually with a long history in fastening industry. The mother company of Apex Fastener was founded in 1993 by the owner who has devoted himself in the industry for over 30 years especially to nut manufacture.

☉ www.apex-fastener.com.tw
 ☉ info@apex-fastener.com.tw
 廣峰科技股份有限公司



_AD.[142]

A-PLUS SCREWS

☉ Floorboard Screws, Thread Forming Screws, High Low Thread Screws, Roofing Screws, Self-drilling Screws, Machine Screws, PT Screws, Triangular Thread Screws, Deck Screws, Customized Special Screws / Bolts, Self-Tapping Screws, Chipboard Screws ☉ We mainly produce stainless steel screws in Vietnam and Taiwan, and are specialized in making Deck Screws. The capacity of our factory is 150~200 tons / per month *Size range: M2~M8 / #2~5/16 *Length range: 4.5mm~200mm / 3/16"~8".

☉ www.a-plusscrewsinc.com.tw
 ☉ master@a-plusscrewsinc.com.tw



_AD.[182]

ARK FASTECH

☉ Clinch Stud, Forged Bolts, Corrosion Resistant Bolts, Custom Bolts, Flanged Head Bolts, HDG Alloy Steel Bolts, Locking Bolts, High Strength Bolts, Roll Thread Bolts, Metal Bolts, Metric Bolts, Shoulder Bolts, Special C-Parts, Cold/Hot Forming Parts, Special Stamping Parts, Special Sintering Parts, High Precision CNC Turning Parts ☉ We assist you in identifying the most suitable maker with your demand, achieving a cost-down target, decreasing the complexity of procurement.

☉ www.arkfastech.com
 ☉ info@arkfastech.com
 方舟扣件科技有限公司



_AD.[096]

ARUN CO., LTD.

☉ Chipboard Screws, Drywall Screws, Bi-metal Screw, High Low Thread Screws, Roofing Screws, Self-drilling Screws, Triangular Thread Screws, Stainless Steel Screws, Deck Screws, Farmer Screws, Particle Board Screws, TEK Screws ☉ Founded in 1993, Arun is one of Taiwan's leading fasteners suppliers. All our products are made in Taiwan, and with various kinds of materials, processes, coatings and packagings available. We supply standard and special fasteners to the global market.

☉ www.arun.com.tw
 ☉ arun@ms27.hinet.net
 鉅耕有限公司



_AD.[261]

ASCCO INTERNATIONAL

☉ Chipboard Screws, Drywall Screws, Wood Screws, Tapping Screws, Machine Screws, Self-drilling Screws, Thread Cutting Screws, Construction Fasteners, Masonry / Concrete / Ceramic and Adhesive Tools, Carpet Tools, Painting Tools, Drywall Tools, Garden Tools, Wood Working Tools, Caulking Glass Tools, Utility Cutting Knife...etc. ☉ We can offer the best support and solution with our R&D team and be in position to offer customized screws according to your specification.

☉ www.ascco.com
 ☉ sales@ascco.com
 今大唯貿易有限公司



_AD.[189]

A-STAINLESS INTERNATIONAL

☉ Chipboard Screws, Thread Cutting Screws, High Low Thread Screws, Roofing Screws, Self-drilling Screws, Plastite Screws, Machine Screws, PT Screws, Concrete Screws, Deck Screws, Farmer Screws, Torx Drive System Screws ☉ Now exceeds 20 years of specialization in stainless steel fasteners and wire, with experience and expertise second to none in the fasteners industry.

☉ www.a-stainless.com.tw
 ☉ astainless@hibox.hinet.net
 淳康國際有限公司





ATOTECH TAIWAN

☉ Zinc Plated, ED Coating, Surface Treatment And Related Equipment ☉ A leading surface-finishing solutions provider, delivering chemistry, equipment, and service to support diverse end-markets such as mobile devices, computers and other consumer electronics, the global automotive industries, and many others. We continuously invest in R&D that enable us to deliver the most innovative and sustainable products.

☉ atotech.com
☉ taiwan.gmf@atotech.com
阿托科技股份有限公司



_AD.[118]

AUTOLINK INTERNATIONAL

☉ Flange Nuts, Tee or T Nuts, Weld Nuts, Wheel Nuts, Machine Bolts, Weld Bolts (studs), Prevailing Torque Nuts, Double-head Screws / Bolts, Open Die Screw, Wheel Bolts, Automotive Screws, Spacers ☉ Autolink is a professional fastener trade supplier in Taiwan, established in 2011. (as the export division, set up and invested by Ming Hui Sheng Enterprise Co., Ltd). Autolink is composed of the leading Ming Hui Sheng Enterprise and other fastener manufacturers invited by Ming Hui Sheng.

☉ www.auto-link.com.tw
☉ info@auto-link.com.tw
宏爵國際有限公司



_AD.[170]

AVIOUS ENTERPRISE

☉ Chipboard Screws, Drywall Screws, Flange Screws, Furniture Screws, Flange Washer Head Screws, High Low Thread Screws, Self-drilling Screws, Machine Screws, 6 Cuts/ 8 Cuts Self Drilling Screw, Wheel Bolts, Self-tapping Screws and Custom Special Design Screws ☉ Avious was founded in 1998 in Taiwan. Our emphasis is on product quality and customer service. We have the most cutting-edge technology and quality control system in the business, and a wide range of products.

☉ www.avious.com.tw
☉ avious@ms43.hinet.net
艾伯斯實業有限公司



_AD.[092]

BCR INC.

☉ Piston Pins, Weld Bolts (studs), Shoulder Rivets, Tubes, Triangular Thread Screws, Turning Parts, Hose Clamp Screws, Automotive Screws, Flange Screws, Flange Washer Head Screws, Hose Clamp Screw for the automotive and industry; Bushing, Sleeve or Spacer for the automotive and industry; Stamping assembly component; Brass Insert for the electronic parts; Special Bolts, Screws and Nuts; Technician supports ☉ BCR is a professional fastener trading company with the ISO9001 certified.

☉ www.bcr.com.tw
☉ bcr.inc@msa.hinet.net
必鉸股份有限公司



_AD.[166]

BESTWELL INTERNATIONAL

☉ Eye Bolts, Flanged Head Bolts, Hanger Bolts, Hexagon Head Bolts, Round Head Bolts, Shoulder Bolts, Stud Bolts, Track Bolts, U Bolts, Wheel Bolts, Nuts, Washers, Thread Rods (carbon steel, alloy, stainless steel, brass, aluminum) ☉ Bestwell International Corp was established in 1983, we have more than 20 years experience on selling our products to U.S.A., South America, Europe, Australia, Africa, Asia..., we provide the best quality, service and value for all customers' need.

☉ www.bestwell.com.tw
☉ bestwell@ms5.hinet.net
凱壹實業股份有限公司



_AD.[030]

BI-MIRTH CORPORATION

☉ Lag Screws, Wood Screws, Zinc Plated, Self-drilling Screws, Twinfast Woodscrews, Carbon Steel Screws, Construction Lag Screws, Chipboard Screws, Self-Tapping Screws, Deck Screws, Construction Fasteners, OEM/ODM ☉ Bi-Mirth Corporation was founded in 1986, with its headquarters in Taichung and plants in Kaohsiung. It introduced coating technology into Taiwan from the U.S. 16 years ago, and mainly manufactures screws for light gauge steel roof and wood construction.

☉ www.bi-mirth.com
☉ sales@bimirth.com.tw
吉瞬興業股份有限公司





_AD.[004]

BOLTUN CORPORATION

☉ Flange Nuts, Hexagon Nuts, Square Nuts, Weld Nuts, Hexagon Head Bolts, Weld Bolts (studs), Conical Washer Nuts, Bushes, Automotive Screws, Nylon Nuts With Conical Washers, Hexagon Washer Head Screws / Bolts, Auto Parts, Components, Stamping Parts, Wind Turbine and Casting Parts
 ☉ Boltun is the leading suppliers in metal parts for industrial use in Taiwan. The company name suggests a mix of 'bolt and nut', which was show the nature of the corporation since 1988.

☉ www.boltun.com
 ☉ sales@boltun.com.tw
 恒耀工業股份有限公司



_AD.[162]

BOSS PRECISION WORKS

☉ Hexagon Head Bolts, Drywall Screws, Wood Screws, Roofing Screws, Self-drilling Screws, Machine Screws, Hexagon Washer Head Screws / Bolts, Self-Tapping Screws, Sheet Metal Screws, Chipboard Screws, SEMS Screws, Flanged Head Bolts
 ☉ Boss Precision Works Co., Ltd. has been certified to ISO-9001. Also, we can customize drawing and new design per request. With in-house QC Lab, we can assure you of fastener quality.

☉ www.screwboss.com
 ☉ sales@screwboss.com
 伯獅精工股份有限公司



BRIGHTON-BEST INTERNATIONAL

☉ Wedge Anchors, Concrete Screws, Blind Rivets, Drywall Screws, Self-drilling Screws, Cutting Tools In General, Adjustable Wrenches, Screwdrivers, Screwdriver Bits, Hex Keys, Hand Rivet Tools, Hand Rivet Nut/rivet Bolt Tools, Air Hydraulic Rivet, Hammers In General
 ☉ The strength of Brighton-Best is the ability to redefine the channel and to build efficiencies throughout the distribution process. *Highest material A2LA / ISO certificated supplier *Complete lot tractability

☉ www.brightonbest.com
 ☉ anne_chen@tachen.com.tw
 大成國際鋼鐵股份有限公司



_AD.[205]

BÜLTE GmbH

☉ Plastic Bolts, Plastic/rubber Materials, Precision Plastic Parts, Plastic Screws, Plastic Nuts, Plastic Washers, Plastic Flat Washers, All Kinds of Screws, Corrosion Resistant Screws, All Kinds of Nuts, Nylon Screws, Nylon Washers
 ☉ The setting up of a network of highly-efficient distributors on a national and international level makes a dynamic and reactive team able to answer all your queries. BÜLTE offers a wide range of standard products in Polyamide as well as specific and innovating parts in various materials.

☉ www.bulte.com
 ☉ info@bulte.com



_AD.[159]

CANATEX INDUSTRIAL

☉ Stamped Parts, Flange Screws, Automotive Screws, Multi-stage Screw & Parts, All Kinds of Screws, OEM/ODM, Automotive Nuts, Bushing, All Kinds of Nuts, CNC Machining Parts, Stainless Steel, Aluminum Material, cold-forging, CNC Machining, Stamping, Deep Drawing, Sintering, Even Metal & Plastic Injection
 ☉ CANATEX is well established in providing standard parts, but also specializes in automotive safety parts, both external and internal thread special parts.

☉ www.canatex.com.tw
 ☉ 104@canatex.com.tw
 保力德股份有限公司



_AD.[133]

CASHI COMPONENTS

☉ Plastic Nuts, Plastic Screws, Small Nuts, Combined Screws, Prevailing Torque Nuts, Turning Parts, Retaining Ring, Miniature Precision Screws, Rivets, Assembly Captive Screws!
 ☉ This company is founded to provide the clients with high quality but low-cost products and emphasizes on developing designing and manufacturing process. We adhere to the principles of : CAREFULNESS/AFFABILITY/SMARTNESS/HONESTY/IMAGE, Spiritual objective of these five principles.

☉ www.cashi.com.tw
 ☉ cashi@cashi.com.tw
 朝業股份有限公司



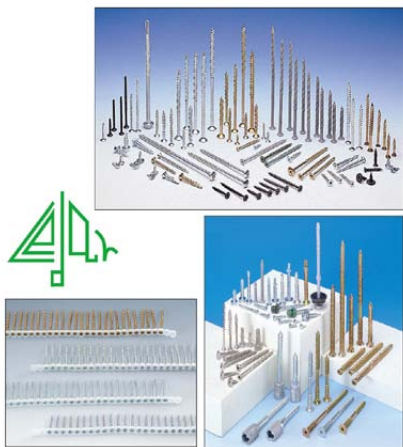

_AD.[255]
CEDAR HOUSE

☎ Lag Screws, Chipboard Screws, Countersunk Screws, Drywall Screws, Floorboard Screws, Sheet Metal Screws, High Low Thread Screws, Roofing Screws, Self-drilling Screws, Self Tapping Screws, Nail Point Screws, Window & Door Frame Screws, Concrete Screws, Carriage Bolts ☎ Established in 1993. Main concept - creation, devotion, service, efficiency. Goals: (1) Customer's satisfaction is our honor (2) Insurance of quality is our responsibility

☎ www.fastener-world.com/en/supplier/cedar

☎ cedarhos@ms62.hinet.net

奕柏股份有限公司



_AD.[215]
CHAN CHIN C. ENTERPRISE

☎ Self-drilling Screws, Self-Tapping Screws, TEK Screws, Chipboard Screws, Furniture Screws, Particle Board Screws, Drywall Screws, Roofing Screws, Wood Screws, Thread Cutting Screws, Special Cutting Screws, Euro Screws, Washers and etc.

☎ Chan Chin C. Enterprise Co., Ltd. was founded in 1987 and engaged in OEM business initially. Thereafter, the business of Chan Chin C. has been successfully transformed to be 100% focused on the export market.

☎ www.chanchinc.com

☎ sales1@chanchinc.com

展進企業股份有限公司



_AD.[062]
CHAN HSIUNG FACTORY

☎ Wheel Bolts, Twelve Point Head Screws, Weld Screws, Mathread Screws, Rivets, Automotive Screws, Button Head Cap Screws, Flange Screws, Weld Bolts (studs), Hexagon Washer Head Screws / Bolts, Track Bolts, Clevis Pins ☎ Established in 1980. Dedicated to specialized automotive fastener research and development. Our belief "Customers First, Quality Best". To achieve customer satisfaction through applying our knowledge and passion to each and every part of the production process.

☎ www.chan-hsiung.com.tw

☎ sales@chan-hsiung.com.tw

全雄工廠股份有限公司



_AD.[183]
CHAN LIANG ENTERPRISE

☎ Chipboard Screws, Drywall Screws, Wood Screws, TEK Screws, Thread Cutting Screws, Triangular Thread Screws, Roofing Screws, Self-drilling Screws, Collated Screws, Concrete Screws, Machine Screws, Deck Screws ☎ Chan Liang Was Established In 1986, Kaoshiung. Up To 600 Tons of Products Monthly. Our Mainly Purposes * Good Quality * Custom Orders And Service * On-Time Delivery and Competitive Pricing Certificates * ISO 9001 * ISO/IEC TAF 17025 Accreditaion for QA Lab * CE14566

☎ www.chanliang.com.tw

☎ chan222@ms27.hinet.net

銓良企業股份有限公司



_AD.[293]
CHANG BING ENTERPRISE

☎ Hook Bolts, Holders / Hooks / Rings, Dowel Screws, Conical Plastic Anchors, Nylon Nail Anchors, Open Die Screw, Eye Screws, Lag Screws, U Bolts, Eye Bolts, Speed Anchor Zinc Alloy ☎ CHANG BING manufacturing bolts, hooks, nails, hangers, bath accessories, hand tools, stamping hardwares with unsurpassed customer service, product innovation and integrity--- and to offer products that would become the first choice among professionals around the world.

☎ www.cbtw.com.tw

☎ changbing@hangers.com.tw

彰濱企業有限公司

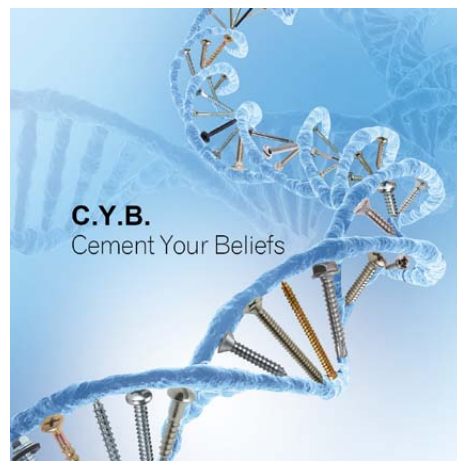

_AD.[135]
CHANG YI BOLT

☎ 6 Cuts/ 8 Cuts Self Drilling Screw, A2 Cap Screw, Chipboard Screws, Coach Screws, Button Head Socket Cap Screws, Cap Screws, Carbon Steel Screws, All Kinds of Screws, Drive Screws, Flat Head & Socket Head Cap Screws, Construction Fasteners ☎ Chang Yi Bolt is a Taiwan-based fastener manufacturer. It was established in 1987 by Mr. Hsin Teng Chen and Ms. Bertha Lee. Chang Yi is located in Gangshan, Kaohsiung where is the biggest scale of fastener valley.

☎ www.changyi.com.tw

☎ changyibolt@hibox.hinet.net

長益螺絲股份有限公司





_AD.[240]

CHANGING SUN METAL

☉ Blind Nuts / Rivet Nuts, Blind Rivet Studs, Closed End Rivets, Countersunk Rivets, Flat Head Rivets, Rivets ☉ Established in 1990, we specialize in producing rivet nuts; we can produce in material steel, stainless steel, aluminum, and brass. We passed ISO 9001:2015 and IATF 16949: 2016 certificates. We have a strong R&D team; we can consistently develop new products while prioritizing product quality and precision. We welcome global buyers to inquire about customized rivet nuts.

☉ www.chgsun.com
 ☉ chgsunall@chgsun.com.tw
 長晉盛金屬有限公司



CHENG HENG INDUSTRIAL

☉ Stainless Steel Cable Ties & Hose Clamps, Hose Clamp, Cable Tie, Metal Tie, Worm Drive Hose Clamp, Ear Clamp, Heavy Duty Clamp, C.V.Boot Hose Clamp, T-Bolt Clamp, 304SS Hose Clip, Stainless Steel Hose Clip. Stainless Steel Cable Ties; SS Cable Ties With Nylon Coated, Pipe Clip, Stainless Steel Strapping, Banding With Buckle, Spring Band, Constant Tension Hose Clamp, Quick Release Hose Clamp, Stainless Steel Band, Band Clamp, Muffler Clamp, Multi-Lock Cable Tie, Ladder SS Cable Ties, Reusable SS Cable Ties

☉ www.hoseclamp.com.tw
 ☉ hose.clamp@msa.hinet.net
 成亨工業股份有限公司



_AD.[157]

CHI HUNG RIVETS WORKS

☉ Blind Rivets, Hollow Rivets, Tubular Rivets, Rivets, Customized Special Screws / Bolts, Washers, Bifurcated Or Split Rivets, Semi-tubular Rivets, Shoulder Rivets, Special Rivets, Caster Pins, Custom Pins ☉ We are ISO 9001 certified. Established in 1966, specialize in manufacturing rivets for more than 50 years. Quality rivets with reasonable prices and prompt delivery time. Equipped by 50 automatic machines. All products are of quality compliant with IFI standard.

☉ www.chihunrivets.com.tw
 ☉ chrivets@tpts8.seed.net.tw
 吉宏鉚釘工業股份有限公司



_AD.[299]

CHIA CHEN ENTERPRISE

☉ All Kinds of Screws, Automotive Screws, Automotive & Motorcycle Special Screws / Bolts, Precision Electronic Screws, Special Screws, Customized Special Screws / Bolts, Self-Drilling Screws, Self-Tapping Screws, Wood Screws, Stainless Steel Screws ☉ Chia Chen Ent. Co., Ltd., with 30,000 square meter factory, located in NinhBinh, Vietnam, and established in 2009. We have more than 25 years of experience and technique in fastener manufacturing.

☉ chiachen3.webnode.tw
 ☉ chiachensalesit@gmail.com



_AD.[273]

CHIA SING SCREW INDUSTRIAL

☉ Hexagon Head Cap Screws, High Low Thread Screws, Turning Parts, Taptite Screws, Plastite Screws, Machine Screws, PT Screws, Combined Screws, Multi-stage Screw & Parts, SEMS Screws, Socket Head Cap Screws, Double-head Screws / Bolts ☉ Chia Sing was founded in Taipei, Taiwan in 1972, specializing in production of various industrial fasteners. Following the "Customer Satisfaction" quality policy, we offer support to domestic and foreign customers.

☉ www.chiasing.com
 ☉ jessica@chiasing.com.tw
 佳興螺絲工業股份有限公司



_AD.[103]

CHIAN YUNG CORPORATION

☉ SEMS Screws, Automotive Screws, Appliance Screws, Military Specification Screws, Precision Electronic Screws, Taptite Screws, Tapping Screws, Screws in Small Packs, Thread Cutting Screws, Carbon Steel Washers, Custom Washers, Belleville Disc Washers ☉ Founded in 1987, Chian Yung has grown steadily because of its dedication to lowering cost and improving quality through a technical approach to fasteners and fixings. Our product size from #2 to 3/8 (M1.4 to M12).

☉ www.chianyungco.com.tw
 ☉ sales@chianyungco.com.tw
 將運螺絲工業有限公司





_AD.[144]
CHIAO CHANG PNEUMATIC TOOL

● Blind Nuts / Rivet Nuts, Rivets, Air Tools General, Air Shears, Pneumatic Hand Tools In General, Hand Tools In General, Hand Rivet Tools, Hand Rivet Nut/ rivet Bolt Tools, Air Hydraulic Rivet, Rivet Nut Tools, Cutting Tools In General, Cordless Power Tools, Powered Tools In General, Auto Repair Tools
 ● CCP TOOL was established in 1983. Its main business types are export, manufacturing, and OEM / ODM. All products are researched, developed, manufactured and inspected in Taiwan.

● www.ccp-tw.com.tw
 ● info@ccp-tw.com.tw
 喬章實業股份有限公司



We are a professional manufacturer of special screws and open die products

_AD.[209]
CHIH FU MECHANICS

● Ball Ended Screws, Ball Screws, Furniture Screws, Socket Head Set Screws, Machine Screws, Open Die Screw, Automotive Parts, Construction Fasteners, Tapping Screws, Drywall Screws, High Low Thread Screws, Ball Stud, Pin Stud, I-shaped Bushing, Tri-Lobular Thread Screw
 ● We are professional for Open Die Screws. Special Screws Manufacturing with Matched Moulds.

● www.chifu.net
 ● andor@chifu.com.tw
 智富機械有限公司



CHIN TAI SING PRECISION MANUFACTORY

● Self-clinching Nuts, Brass Insert ● Chin Tai Sing Precision Manufactory is one of the most professional manufacturers in Taiwan who offers various precision plastic mold in Brass Insert and Clinching Metal Fasteners for Pre-heating, Ultrasonic and Press-in, Screw-in. We offer various precision plastic mold in Brass Insert and Clinching Metal Fasteners for Pre-heating, Ultrasonic and Press-in, Screw-in. CTSP Manufactory formed by several professional staffs who have over 20 years production experience.

● www.ctsp-insert.com.tw
 ● inquiry@ctsp-insert.com.tw
 金泰興精密緊固有限公司



_AD.[226]
CHINA PNEUMATIC

● Torque Wrench, Torque Sensor Calibration, Blind Rivet Assembly Machine, Torque/clamping Force Testing System, Air Screwdrivers, Cordless Power Tools, Blind Rivets, Blind Nuts / Rivet Nuts, Impact Screwdrivers, Hydraulic Tools In General, Air Tools General, Pneumatic Hand Tools In General
 ● China Pneumatic (CPC) is an ISO - 9001 certified manufacturer of professional / industrial pneumatic tools, precision planetary gear reducers and machined parts from Taiwan with more than 30 years of OEM / ODM experience.

● www.zippgroup.com
 ● derrick@airtools.com.tw
 中國氣動工業股份有限公司



CHIN-TIEH SCREW

● Construction Fasteners, Self-drilling Screws, Concrete Screws, Bi-metal Screws, Carbon Steel Screws, Double-head Screws / Bolts, Drywall Screws, Flange Screws, Self-Tapping Screws, Hexagon Washer Head Screws / Bolts, Twinfast Woodscrews, Security Screws, Stainless Steel Screws, Long Screws
 ● Professional Customized Screw Supplier Chin-Tieh Screw Co. Transformed to Fastener R&D and Manufacture Chin-Tieh Screw has been operating for more than 20 years in a 1,100 square meters manufacturing facility located in Taiwan.

● www.best-screw.com.tw
 ● chintieh@best-screw.com.tw
 進鐵螺絲廠

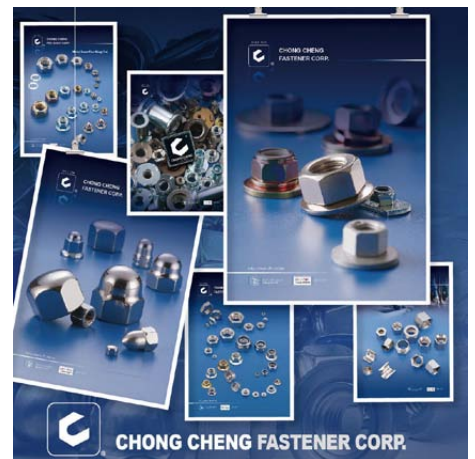

_AD.[046]
CHONG CHENG FASTENER

● Cap Nuts, Coupling Nuts, U Nuts, Weld Nuts, Conical Washer Nuts, Flange Nylon Nuts With Washers, Prevailing Torque Nuts, Top Lock Nuts With Conical Washer Assemble, Breakaway Nuts, Automotive Nuts
 ● CFC established in 1989. The company started with the manufacturing of kep. nut and till the present, the number of the major product items has been over 35, including nuts of various materials such as steel, copper alloy, aluminum alloy, etc.

● www.cfc.net.tw
 ● sales@cfc.net.tw
 宗鉦企業股份有限公司





_AD.[134]

CHU WU INDUSTRIAL

● Miniature Precision Screws, PT Screws, Triangular Thread Screws, Customized Special Screws / Bolts, Combined Screws, High Low Thread Screws, SEMS Screws, Thread Forming Screws, Screw Washer Assembling Machine, Precision Electronic Screws, Tamper-proof Screws, Instrument Screws, Micro Screws, Clinching Parts, Machining Parts ● Chu Wu was established in 1985. Our total service, top quality, good price and prompt delivery etc, enjoy a good reputation from our clients worldwide.

● www.chuwu.com.tw
● sales@chuwu.com.tw
雷堤實業有限公司



CHUN YU WORKS

● Wheel Bolts, Chipboard Screws, Drywall Screws, Hexagon Head Cap Screws, Socket Head Cap Screws, Weld Screws, Thread Forming Screws, Collated Screws, SEMS Screws, Automotive & Motorcycle Special Screws / Bolts, Construction Fasteners, Flange Screws ● Our quality management system is implemented throughout the process from raw materials to finished goods and packaging to delivery with ISO9001 and IATF 16949 certified. Main products are automotive fasteners.

● www.chunyu.com.tw
● arthur@chunyu.com.tw
春雨工廠股份有限公司



_AD.[180]

CLC INDUSTRIAL

● Hexagon Nuts, Special Nuts, All Kinds of Nuts, Copper Nuts, Kep Nuts, American Standard Nuts, Flange Nuts, Prevailing Torque Nuts, Square Nuts, Small Nuts, Tee Nuts, Nylon Insert Nuts ● Established in 1988; Factory location: Tainan City, Taiwan; Certification: ISO 9001; Market: Europe 50% U.S.A 30%, JAPAN 10%, Others : 10%; Material: Stainless Steel, Carbon Steel, Brass C2700/C2600 Silicon Bronze 651; Size: M1.6-M24, #0-1", Packing: Bulk in carton, Small box

● www.clc-nuts.com.tw
● clcnuts@clcnuts.com.tw
聖泰工業股份有限公司



_AD.[089]

CHIN LIH HSING PRECISION ENTERPRISE

● Automotive Nuts, Clinch Nuts, Bushes, Bushings, Hex Stand-offs, Insert Nuts, Inserts For Plastic, Brass Inserts, Turning Parts ● Chin Lih Hsing is a privately owned company specialized in manufacturing all types of precision metal parts and thread inserts. Founded in 1988, Chin Lih Hsing offers various thread fasteners for plastic moulds. The products range includes fasteners suitable for thermo-set, thermoplastic, SMC, GRP and structural foam material.

● www.clh.com.tw
● clh@clh.com.tw
金利興精密企業有限公司



_AD.[153]

COPA FLANGE FASTENERS

● Flange Nuts, Weld Nuts, Lock Nuts, Special Nuts, Cold Forged Nuts ● Established in 1998, COPA has over thirty years' experience of producing high-quality nuts and fasteners for numerous global industries. Our main products are used in the global automotive industry, exporting to countries such as the United States, Netherlands, Denmark and Germany. The main products are various types of nuts and have been approved by IATF 16949:2016.

● www.copa.com.tw
● sales@copa.com.tw
國鵬工業股份有限公司



_AD.[111]

CPC FASTENERS INTERNATIONAL

● Bi-metal Self-drilling Screws, Sheet Metal Screws, Bi-metal Screw, TEK Screws, Roofing Screws, Self-drilling Screws, ZDC Cap Screws, Thread Forming Screws, Special Parts, Automotive Screws, Stainless Steel Screws ● Established in 1999, we have been operating and building customer bases located across the world, including places such as the Taiwanese local market, South East Asia, America and Europe. We have earned ourselves a good reputation among our customers.

● www.cpc-fasteners.com
● sales@cpc-fasteners.com
冠誠國際股份有限公司



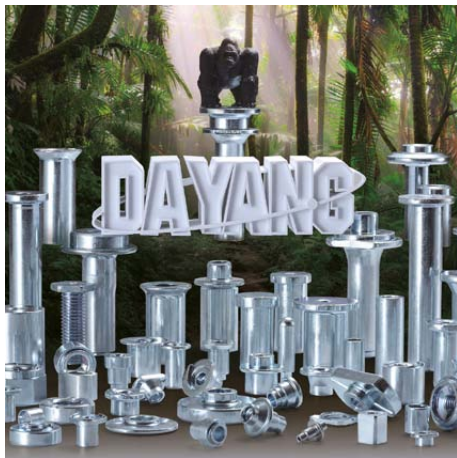

_AD.[021]
DA YANG ENTERPRISE

Ⓞ Automotive Nuts, Weld Nuts, Spacers, Bushing, Washers Ⓞ Da Yang Co., Ltd was founded in 1992. We are a leading automotive nut manufacturer of Weld Nuts and Special Nuts located in Ben Gong Industrial Park and equipped with production facilities, including forming, tapping, washing and optical sorting machines. Da Yang possesses strong and superb research and exercises strict quality control. To gain strong confidence from our customers, Da Yang is now certified with IATF16949.

Ⓞ www.specialnuts.com.tw
Ⓞ dayang1@ms39.hinet.net
大楊實業股份有限公司



_AD.[278]
DAH SHAN PLASTICS

Ⓞ Plastic/rubber Materials Ⓞ Dah Shan Plastics Co., Ltd. was established in 1989. Currently there are a total of 15 production lines supplying processing products made of both soft and hard texture plastic raw materials. We can adopt ABS, HIPL, PE, PP, PVC, PS, NBR, TPE, TPR etc. raw materials in accordance with product characteristic requirements, at the same time provide various colors and surface patterns for selection, making products abundant in colors and beautiful appearances. We can do forming size up to 1220mm in width.

Ⓞ www.dahshan.com.tw
Ⓞ ltid@ms17.hinet.net
大山塑膠股份有限公司



_AD.[122]
DAR YU ENTERPRISE

Ⓞ Chipboard Screws, Drywall Screws, Screw Nails, Steel Nails, (Steel) Wire Nails, Bit & Bits Sets, Fastener Kits, Roofing Screws, Screwdrivers, Wood Screws, Self-Tapping Screws, Carbon Steel Washers Ⓞ Dar Yu is one of the most innovative and supportive suppliers of leading chained stores in Europe, the US and Japan in DIY fasteners, household accessories, and hand-tools. In 1989, Dar Yu was founded in Taiwan and started with the business of fasteners distribution. To fulfill customers' growing demands on different packagings on the DIY market.

Ⓞ www.dar-yu.com.tw
Ⓞ info@dar-yu.com.tw
達宇股份有限公司



_AD.[219]
DA-WANG SCREW INDUSTRIAL

Ⓞ A2 Cap Screw, Alloy Steel Screws, Appliance Screws, Assembly Captive Screws, Customized Special Screws / Bolts, Machine Screws, Socket Head Cap Screws, Socket Head Set Screws, Flange Screws, Metric Screws, Multi-stage Screws & Parts, Torx Drive System Screws Ⓞ Da-Wang founded in 1980 has been a leading manufacturer of screws in Taiwan. Da-Wang specializes in fasteners, nuts, washers and wrenches in alloy steel, stainless steel, medium carbon steel, brass, aluminum.

Ⓞ www.dwscrew.com
Ⓞ service@dwscrew.com
達旺螺絲工業股份有限公司



_AD.[200]
DE HUI SCREW INDUSTRY

Ⓞ Drywall Screws, Construction Fasteners, Collated Screws, Torx Drive System Screws, Deck Screws, TEK Screws, Self-drilling Screws, Roofing Screws Ⓞ De Hui was established in 1988 with a capital of \$5 million NT. We began with OEM of screws and, in 1991, we established a packaging plant and started to transform into a company that accepts export orders. De Hui cooperate with alliance plants (Heat treatment plant, Surface finishing plant), to control each step of QC test.

Ⓞ www.dehuiscrew.com
Ⓞ dehui@dehuiscrew.com
德慧螺絲工業股份有限公司



_AD.[246]
DE XIN METAL (TAIWAN)

Ⓞ Machine Screws, PT Screws, Tapping Screws, Chipboard Screws, Tri-lobular Thread Screws, Wood Screws, Hi-Lo Screws, Rivets Ⓞ Best manufacturer for your choice! Customized / Inspection Capacity, Production Range: M3-M10; Length 5mm-100mm, Recess: 6-lobe, Hex Socket, Phillips, Slot, Pozzi...

ISO 9001:2015 & ISO 28000:2007 Certified

Ⓞ www.fastener-world.com/en/supplier/dexin
Ⓞ dxm057.chou@gmail.com
得鑫五金股份有限公司





_AD.[213]

DELTEKS INDUSTRIES

☉ Precision Cold Formed Parts, Wheel Bolts, Bushes, Thread Forming Screws, Thread Cutting Screws, Turning Parts, Rivets, Automotive & Motorcycle Special Screws / Bolts, Ball Ended Screws, Customized Special Bolts, Garage Door Rollers Bearingless, Injection Molded Glides, Precision Secondary Operation, CNC Machining, Stamping, Welding ☉ Delteks utilizes state-of-the-art multi-die multi-blow bolt and part formers to produce precision cold formed parts.

☉ www.delteks.com.tw
 ☉ charles@delteks.com.tw
 見承企業有限公司



DICHA SOMBRILLA

☉ Expansion Anchors, Sleeve Anchors, Nylon Nail Anchors, Nail In Anchors, Easy Anchors, Anchors, Hammer Drive Anchors, Speed Anchor Zinc Alloy, Hollow Wall Anchors, Conical Plastic Anchors, E-z Anchor Nylon ☉ DICHA was established in 1984, we have been working in this field for more than 30 years with professional and mature technic. We are a manufacturer and exporter that could achieve customers' requirements. Our company runs with ideas of quality, satisfaction, competitive pricing, and in time delivery.

☉ www.dicha.com.tw
 ☉ service@topseat.com.tw
 集財實業有限公司



_AD.[Cover page]

DIING SEN FASTENERS INDUSTRIAL

☉ Chipboard Screws, Drywall Screws, Thread Rolling Screws, Wood Screws, TEK Screws, High Low Thread Screws, Self-drilling Screws, Machine Screws, Twinfast Woodscrews, Deck Screws, Collated Screws, Corrosion Resistant Screws ☉ LIH LIN was established in 1981. The group has more than 1200 employees now. There are two plants in Taiwan (Taipei and Kaohsiung) two plants in Vietnam (South and North Vietnam), one plant in Cambodia and one plant in China (SuZhou).

☉ www.fastener-world.com/en/supplier/lih-lin
 ☉ lihlin88@ms36.hinet.net
 鼎銀企業股份有限公司



Wood Building Screw

12 STAR PATENT NO: 1622444

WBS[®]

Durchmesser / Diameter
 Länge / Length

3.0	3.5	4.0	4.5	5.0
5.0	8.0	10.0	12.0	mm
25 - 600 mm				

Automobile ASSORTMENT

IATF 16949 - 2016



_AD.[125]

DRAGON IRON FACTORY

☉ Bi-metal Self-drilling Screws, Sheet Metal Screws, Thread Forming Screws, Bi-metal Screws, TEK Screws, Thread Cutting Screws, Triangular Thread Screws, Roofing Screws, Self-drilling Screws, Tapping Screws, TapTite Screws, Self-Tapping Screws, Drywall Screws, Chipboard Screws, Roofing Screws, Window Screws, Special Screws ☉ Dragon Iron was established in 1973. Dragon Iron is actively involved in a variety of products, exported to Africa, America, Asia, Australia, and Europe.

☉ www.dragoniron.com.tw
 ☉ dragonco@hibox.hinet.net
 龍昌螺絲工廠股份有限公司



- Self-Drilling Screw
- Drywall Screw
- High Low Thread Screw
- Machine Screw

- Chipboard Screw
- Concrete Screw
- Wood Screw
- Stainless Steel Screw

_AD.[154]

DRA-GOON FASTENERS

☉ All Kinds of Screws, Phillips Head Screws, TEK Screws, High Low Thread Screws, Roofing Screws, Self-drilling Screws, Machine Screws, Bi-metal Screws, Corrosion Resistant Screws, Construction Fasteners, Customized Special Screws / Bolts, Bi-metal Self-drilling Screws, self Tapping, Drywall, Chipboard and Particle Board Screws ☉ Dra-Goon is a screw manufacturer and exporter established in 1994 in Kaohsiung, Taiwan. We are an ISO 9001 certified company since 2003.

☉ www.dra-goon.com.tw
 ☉ dra.goon@msa.hinet.net
 丞曜實業有限公司



_AD.[080]

DIN LING CORP.

☉ Chipboard Screws, Drywall Screws, Furniture Screws, Flange Washer Head Screws, Self-drilling Screws, Machine Screws, Hexagon Washer Head Screws / Bolts, PT Screws, Concrete Screws, Construction Fasteners, Deck Screws, Wood Screws, Self-Tapping Screws, Special Screws ☉ We have been working in the fastener industry for more than 29 years and 90% of our products are for exporting to European market. We own 2 factories which are located in Taiwan & Vietnam.

☉ www.din-ling.com
 ☉ ldinling@din-ling.com
 登琳實業股份有限公司





_AD.[128]

DUNFA INTERNATIONAL

● Bushes, Spacers, Automotive Parts, Tubes, Turning Parts ● Dunfa is a professional manufacturer and exporter of cold forming parts. Founded in 1986, we have kept researching and developing new products for over 20 years. We also keep updating manufacturing facilities for promoting quality and service. Besides, our strict management and serious working attitude will convince you to have a strong confidence in our products.

● www.dunfa.com.tw
● nicole@dunfa.com.tw
敦發國際貿易股份有限公司



DYNWARE INDUSTRIAL

● All Kinds of Screws, Automotive & Motorcycle Special Screws / Bolts, Concrete Screws, Bi-metal Screws, Hose Clamp Screws, SEMS Screws, Special Screws, Special Nuts, Bushings, Sleeve Anchors, Cotter Pins, Flat Washers ● Dynaware Industrial Inc. has been an exporter in Taipei for over two decades. Our major exported products are fasteners (screws/nuts/washers) and industrial components. Our factories are located in Taiwan, China and Southeast Asia.

● www.fastener-world.com/en/supplier/dynaware
● dynaware@ms65.hinet.net
盈洋企業有限公司



_AD.[437]

E & K TECH LTD.

● Motorcycle Nuts, Sleeve Nuts, Blind Rivets, Fastener Kits, Rivets, CNC Machining Parts, Die Casting, Turning Parts, Stamped Parts, Shaft Couplings, Special Parts ● A Swedish-Taiwanese Joint venture. Office in Shenzhen, Warehouse in Shenzhen. Your partner in China for worldwide business, exporting, importing and domestic businesses. Various, versatile products and services. High quality, good price, on time delivery and responsibility.

● www.enkchina.com
● lisa@enkchina.com
伊而凱貿易(深圳)有限公司



_AD.[131]

E CHAIN INDUSTRIAL

● Chipboard Screws, Self-drilling Screws, Machine Screws, Tapping Screws, Drywall Screws, Weld Nuts, Weld Screws, Automotive & Motorcycle Special Screws / Bolts, Eye Bolts, Concrete Screws, A194-gr. 2h Nuts, Cold Forged Nuts ● We specialize in providing high quality fastener and hardware products. Our extensive product range from regular standard items such as follows: 1. Bolts & Screws 2. Welding Nuts & Bushing 3. Turning Parts 4. Close Dies Parts.

● www.sqf.com.tw
● sales@ech.com.tw
毅程工業股份有限公司



_AD.[161]

EASON TECH INDUSTRIAL

● Spring Pins, Cage Nuts, Clip Nuts, Square Nuts, U Nuts, Wing Nuts, Spring Bolts, Wheel Bolts, Socket Head Set Screws, Retaining Ring, Chipboard Screws, Drywall Screws, High-Low Screws, Standard, Non-Standard And Customized Nuts ● Established in 1987 in Taiwan, Eason has had over 19 years of solid experience in the screw manufacturing business. We offer a wide range of quality screws, and our screws have been delivered around the world.

● www.easonindustrial.com.tw
● sales@easonindustrial.com.tw
鈺森科技工業股份有限公司



_AD.[059]

EASYLINK INDUSTRIAL

● Automotive Nuts, Chipboard Screws, Thread Forming Screws, Hexagon Washer Head Screws / Bolts, Assembly Captive Screws, Automotive & Motorcycle Special Screws / Bolts, Double-head Screws / Bolts, Furniture Screws, Construction Fasteners, Weld Screws, Alloy Steel Screws, Special Washers ● Taiwan factory: focuses on high level fasteners, like auto parts, electronic parts. -Vietnam factory: focuses on high volume with competitive price demand.

● www.easylink.com.tw
● sales@easylink.com.tw
易連工業股份有限公司



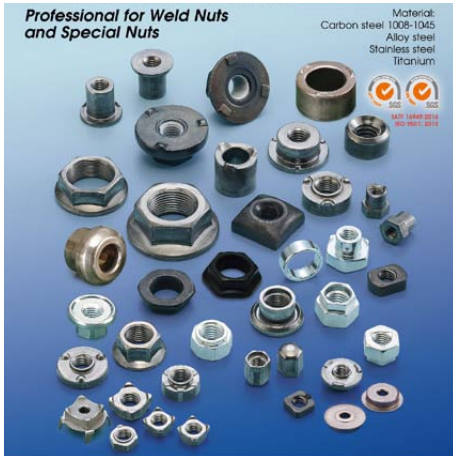

_AD.[435]

EVER-TOP HARDWARE

☉ Automotive Nuts, Castle Nuts, Flange Nuts, Heavy Nuts, Tee or T Nuts, Weld Nuts, Spacers, Cold Forged Nuts, Acme Nuts, Special Nuts
 ☉ Ever-Top Hardware Corporation was established in 1993. we put effort on high quality, developing special nuts and service for satisfying customers' requirements. Our major products are welding nuts and special nuts M4 to M27 as per customer drawings, over 1650 sizes in total, for the AUTO market.

☉ www.evertop-nut.com
 ☉ ethc@evertop-nut.com
 祥頂實業股份有限公司



_AD.[267]

EVEREON INDUSTRIES

☉ Embossed Worm Gear Hose Clamps, Worm Drive Hose Clamps, Ear Clamps, CV Joint Boot Clamps, Specialty Clamps, Assortment Kits
 ☉ EVEREON is a leading designer and manufacturer of stainless steel worm gear, worm drive and specialty hose clamps for almost all industrial and commercial hose application including auto, industrial, plumbing, agriculture, marine, and heavy duty market. EVEREON is located in Taiwan since 1994. YDS hose clamp is our brand.

☉ www.ydshoseclamps.com
 ☉ hoseclamp@eveeon.com.tw
 永德興股份有限公司



_AD.[020]

FAITHFUL ENGINEERING PRODUCT

☉ Hanger Bolts, Chipboard Screws, Drywall Screws, Flat Head & Socket Head Cap Screws, Box Nails, Anchors, Stainless Steel Wire & Rod, Safety Hooks, Hooks, Door and Window Accessories, Handles, Masonry Nails
 ☉ FAITHFUL is a leading supplier in worldwide DIY market. We provide integrated product lines and unique consumer-oriented manufacturing technology. Since 1974, we have been exporting high quality prepacked hardware and fasteners.

☉ www.faithful.com.tw
 ☉ fepco@faithful.com.tw
 誠毅股份有限公司



_AD.[081]

FALCON FASTENER

☉ Chipboard Screws, Thread Rolling Screws, Taptite Screws, Cap Screws, Self-drilling Screws, Plastite Screws, Machine Screws, Self-Tapping Screws, Weld Screws, Tapping Screws, Concrete Screws, High Low Thread Screws
 ☉ Falcon was founded in 2007 as a professional exporter, providing the wide range of fasteners to customers around the world. Our factory was established in 2015, the strength of making parts on our own and the cooperation with various qualified manufacturers.

☉ www.falcon-senda.com.tw
 ☉ falcon.senda@msa.hinet.net
 鉅達國際股份有限公司



_AD.[002]

FANG SHENG SCREW

☉ Hexagon Socket Head Shoulder Screws, Hexagon Flange Bolts, Socket Head Bolts, Button Head Socket Cap Screws, Flange Screws, Flat Head & Socket Head Cap Screws, Hexagon Head Cap Screws, Socket Head Set Screws
 ☉ Fang Sheng (YFS) is one of the world's largest manufacturers of socket screws. Founded in 1979, YFS offers a broad line of quality socket products and services. YFS products are manufactured from high tensile Alloy Steel, Class 12.9 and ASTM A574.

☉ www.yfs.com.tw
 ☉ erie@mail.yfs.com.tw
 芳生螺絲股份有限公司



_AD.[114]

FAREAST METAL INTERNATIONAL

☉ Dowel Pins, Flange Screws, Metric Pins, Locating Pins, Straight Pins, Steel Pins, Roll Pins, Femico Pin (Patented), High Tensile Flange Screws with Ribs Serration, DIN 7979D Pullout Pins, DIN 6325, Hex Flange Bolts, 12 Point Flange Bolts, Grain Bin Bolts
 ☉ We are a hex flange screws and parallel dowel pins expert in Taiwan. We are a company built around a single idea, that quality starts from the very beginning. We see "Do One Thing, Do It Incredibly Well" as a way of thinking.

☉ www.femico.com
 ☉ sales@femico.com
 億萬年貿易股份有限公司





_AD.[088]
FASTENER JAMHER TAIWAN

⊕ Automotive Nuts, Flange Nuts, Knurled Nuts, Tee or T Nuts, Weld Nuts, Prevailing Torque Nuts, Bushing, Blind Nuts / Rivet Nuts, Cold Forged Nuts, Lock Nuts, Special Nuts, Tubular Nuts, Nylon Flange Nuts, T-Tube, Rollers, Sleeves, OEMs, etc.
⊕ Fastener Jamher – Superior supplier of auto fasteners. The company has many years of experience in manufacturing, R&D for fastener products, which can provide standard and customized blind nuts in complete specifications.
⊕ www.jamher.com
⊕ fastener@jamher.com
⊕ 贊賀五金股份有限公司



_AD.[053]
FASTNET CORP.

⊕ Dowel Pins, Flange Nuts, Weld Nuts, Flanged Head Bolts, Headless Set Screws, Self-drilling Screws, Double-head Screws / Bolts, Rivets, 4 Pronged T Nuts, All Kinds of Screws, Castle Nuts, Precision Electronic Screws ⊕ FASTNET is a trading company focusing on fastener export from Taiwan. Focusing on sales, Fastnet enjoys a database of no less than 100 suppliers in Taiwan in five categories of fastener products.
⊕ www.fastnetcorp.com.tw
⊕ fastnet.corp@msa.hinet.net
⊕ 俊鈺股份有限公司



_AD.[109]
FILROX INDUSTRIAL

⊕ Blind Nuts / Rivet Nuts, Tee or T Nuts, Blind Rivets, Internally Threaded Rivets, Blind Rivet Studs, Tee Nuts, Rivets, Anchors, 4 Pronged T Nuts, Hollow Rivets, Semi-tubular Rivets, Chicago Screws ⊕ Filrox Industrial located in Taiwan, is a professional manufacturer of screws, rivets, blind rivets, blind rivet nuts and related parts. Manufacturing metal fasteners has been our profession for the last thirty years. The company is accredited by ISO 9001 TUV CERT and IATF 16949 TUV CERT.
⊕ www.filrox.com.tw
⊕ filroxco@ms54.hinet.net
⊕ 惠錄工業股份有限公司



_AD.[112]
FONG PREAN INDUSTRIAL

⊕ Drywall Screws, Wood Screws, Bi-metal Screw, Roofing Screws, Self-drilling Screws, Machine Screws, Collated Screws, Stainless Steel Screws, Concrete Screws, Deck Screws, TEK Screws, Special Screws ⊕ Fong Prean is a 100% Taiwanese fastener manufacturer established in 1986. We offer professional service to assure the right and interest of each party and sustainable development. And, we also focus on the needs of end users to continue improvement with our R&D team.
⊕ www.fongprean.com
⊕ export1@ms.fongprean.com.tw
⊕ 豐鵬工業股份有限公司



_AD.[187]
FONG WUNS CO., LTD.

⊕ Automotive Nuts, All Kinds of Nuts, Cap Nuts, Flange Nuts, Flange Nylon Nuts With Washers, Forged Nuts, Metal Nuts, Weld Nuts, Special Nuts, Hexagon Nuts, Prevailing Torque Nuts
⊕ Established Date: 1992; Capital: 1 Million US Dollars; Turnover: 18 Million USD-2016; (USA- 40%, Europe- 40%, Asia- 15%, Domestic- 5% Direct, Export- 30%, Indirect Export- 65%); Factory Size : 7,656 Square Meters.
⊕ www.fongwuns.com.tw
⊕ fw@fongwuns.com.tw
⊕ 鋒汶股份有限公司



_AD.[130]
FONG YIEN INDUSTRIAL

⊕ Lifting Hardware, DIN 444 Eyebolts, JIS B1168/1169 Eye Bolts/Eye Nuts, ASME B18.15 Forged Eyebolts, Custom-Made Eye Bolts, Custom-Made Cold Headed Fasteners and Precision Machined Components, Specialty Fastener
⊕ Fong Yien was established in 1974. In 1996, we introduced Multi-stages Bolt Former and became one of the few manufacturers having dual capabilities for cold heading and hot forging production in Taiwan.
⊕ www.fongyien.com
⊕ fongyien@ms43.hinet.net
⊕ 宏盈工業有限公司





_AD.[038]

FORTUNE BRIGHT INDUSTRIAL

☉ Cap Nuts, Dome Nuts, Flange Nuts, Ring Nuts, Self-locking Nuts, U Nuts, Weld Nuts, Nylon Cap Insert Lock Nuts, Prevailing Torque Nuts, Triple Lock Nuts, Conical Ring Lock Nuts, Safety Nuts, Conical Washer Nuts, Metal Insert Conical Nuts ☉ Fortune Bright always takes "Satisfy Customers" as quality policy and "Customers' Satisfaction, On Time Delivery" as quality goal. Our products cover hexagon head (DIN980M), cap, flange nut (DIN6927) and some special specifications.

☉ www.safety-nut.com
☉ fb888@ms14.hinet.net
鋒沐股份有限公司



FOUNTAIN FASTENER

☉ Flange Nuts, Weld Nuts, Special Nuts, Flange Weld Nuts, Round Weld Nuts, T Weld Nuts, Special Weld Nuts ☉ Fountain Fastener, established in 2017, is a company invested by several excellent fastener manufacturers in Taiwan. Being a new company though, our team has fastener experience of more than ten years. We know very well what customers require. Our knowledge of the automobile field enables us to stand out in front of competitors. Professionalism and substantial experience are what we attract our customers around the world.

☉ www.fountain-fastener.com
☉ info@fountain-fastener.com
原詮貿易股份有限公司



_AD.[076]

FU HUI SCREW INDUSTRY

☉ Hanger Bolts, Penta-head Bolts, Shoulder Bolts, Square Head Bolts, T-head or T-slot Bolts, Track Bolts, Wheel Bolts, Flange Washer Head Screws, Double-head Screws / Bolts, Automotive & Motorcycle Special Screws / Bolts, Special Cold / Hot Forming Parts, Automotive Parts ☉ Professional cold forming manufacturer. Specialized in producing customized engineered parts. Excellent product quality & punctual delivery is our commitment to all customers.

☉ www.fuhui.com.tw
☉ fht@ms39.hinet.net
福輝螺絲工廠股份有限公司



_AD.[164]

FU KAI FASTENER ENTERPRISE

☉ Precision Electronic Screws, Special Screws, Weld Screws, Torx Drive System Screws, Triangular Thread Screws, All Kinds of Screws, Button Head Socket Cap Screws, Clinch Stud Screws, Flange Washer Head Screws, Furniture Screws, SEMS Screws, PT Screws ☉ We are a screw factory from Taiwan. We have operated screws business since 1981. We provide high quality, best service and solutions of screw fittings. We are also good at customized products.

☉ www.fkfastener.com.tw
☉ fukai.ht@msa.hinet.net
福凱螺絲企業有限公司



FULIHDER ENTERPRISE

☉ Locking Screws, Locking Bolts, Self-locking Bolts ☉ We are a professional screw maker in Taipei, Taiwan. Our quality is guaranteed from screw manufacturing to glue processing according to your requests. Please contact us for any inquiries or questions. We are a professional screw maker in Taipei, Taiwan. Our quality is guaranteed from screw manufacturing to glue processing according to your requests. Please contact us for any inquiries or questions.

☉ www.fastener-world.com/en/supplier/ful
☉ fufu3332002@yahoo.com.tw
富麗德實業有限公司

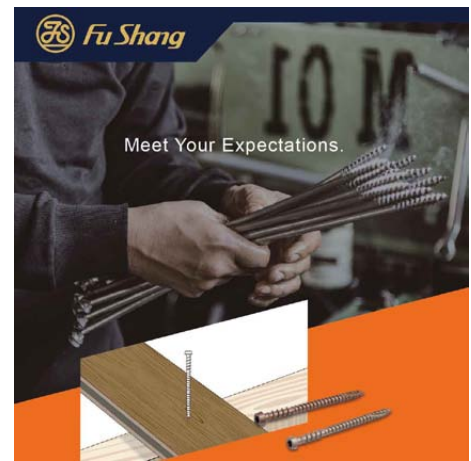

_AD.[100]

FUSHANG CO., LTD.

☉ Carbon Steel Screws, Chipboard Screws, Concrete Screws, Composite Screws, Construction Fasteners, Customized Special Screws / Bolts, Deck Screws, Furniture Screws, Hexagon Head Cap Screws, Roofing Screws, Wood Screws ☉ At FS serving customers right is the principle of our making. Relentless pursuit of perfection is our goal, uncompromising quality is our life and to share wealth and benefits among employees is in the soul of FS.

☉ fushang.com.tw
☉ tcs@fushang.com.tw
甫商有限公司





_AD.[176]
GELA & COMPANY

• Expansion Anchors, Eye Bolts, Hanger Bolts, T-head or T-slot Bolts, Track Bolts, U Bolts, Weld Bolts (studs), Wheel Bolts, Anchor Bolts, All Kinds of Screws, Automotive & Motorcycle Special Screws / Bolts, Custom Washers • We are a manufacturer of special fasteners for various industries: automotive, anchor, industrial machinery, T-bolt, eye bolts, dowel bolts, special in multi-stroke screw wheel bolt, etc. Any design are welcomed.

• www.fastener-gela.com.tw
• victory2502768@gmail.com
蕙寶實業股份有限公司



_AD.[228]
GINFA WORLD

• Chipboard Screws, Countersunk Screws, Drywall Screws, Phillips Head Screws, High Low Thread Screws, Roofing Screws, Self-drilling Screws, Machine Screws, PT Screws, Masonry Screws, Furniture Screws, PC Drywall Nails, Coil Nails, Concrete Nails & Special Nails • We are a manufacturer & exporter of screws & nails in Taiwan & China. Our monthly production of screws & nails is about 800M to 1000M tons.

• www.ginfa.com.tw
• gifa@ms15.hinet.net
濟音發股份有限公司



_AD.[104]
GOFAST CO., LTD.

• Weld Nuts, T-head or T-slot Bolts, Weld Bolts (studs), Ball Ended Screws, Flare Nuts, Double-head Screws / Bolts, Automotive & Motorcycle Special Screws / Bolts, Automotive Nuts, Automotive Parts, Special Bolts, Special Rivets, Turning Parts • Gofast is the top supplier of industrial fasteners and engineering components for worldwide OEM market since 1986. We are a professional organization constantly challenging market boundaries and searching for new solutions.

• www.gofast.com.tw
• fastener@gofast.com.tw
喬邁企業股份有限公司



_AD.[436]
GREEN TECH FASTENERS

• Stainless Steel Self Drilling Screws, Metal Screws, Window Hardware, Automotive Nuts, Automotive Screws, Automotive & Motorcycle Special Screws / Bolts, Construction Fasteners • Green Tech has more than 2 decade experience in dealing in fasteners, and is familiar with requests from automotive, vehicles and construction markets. It also knows well about ISO 9001 & IATF 16949 requirements & has been trained well with all processes, even VDA 6.3 & CQI request.

• www.greentechfast.com
• angela.liu@greentechfast.com



GUANG ZHE ENTERPRISE

• Collated Washer Paper Tape, Collated Screw Tape, Assembly Integrating Paper Tapes and Washers • GUANG ZHE Releases Patented Assembly Integrating Paper Tapes and Washers, New Eco-friendly Option for Collated Screws. Guang Zhe Enterprise Co., Ltd. has recently released a new paper tape, which is recyclable, safe-to-use, eco-friendly and of a pleasing appearance. This tape can be painted and heated at the temperature of up to 200 degrees Celsius for 30 minutes.

• www.fastener-world.com/en/supplier/guangzhe
• sunfuecheng@hotmail.com
光拓企業有限公司



_AD.[123]
HAO CHENG PLASTIC

• Plastic Box, PET Jars, Square Pail, Round Pail, Mini Bottle, Plastic Bucket, Micro Case, Mini Case, Mini Accessory Case, Plastic Case • HCP was established in 1993 and has been specializing in developing plastic boxes for the Fastener Industry. HCP's boxes have been used for packing various screws, bolts, nails and hardware for major companies around the globe. We're dedicated in continuing to meet the needs of our customers and improving the development of environmentally safe packages.

• www.hcplastic.com.tw
• info@hcplastic.com.tw
皓正股份有限公司





_AD.[253]

HAO MOU NUTS MFG.

☉ Tee or T Nuts, Weld Nuts, Spacers, Bushing, Clinch Nuts, Blind Nuts / Rivet Nuts, Special Nuts, Automotive Nuts, Pierce Nuts and those according to drawing. ☉ Hao Mou is an ISO 9001 and IATF 16949 certified manufacturer and exporter in Gangshan, Kaohsiung, Taiwan since 1984. With over 35 years of professional experience in the fastener industry, our core value is to bring customers high quality products and excellent services to meet customers' goals.

☉ www.fastener-world.com/en/supplier/hao-mou
 ☉ haomou.taiwan@msa.hinet.net
 豪茂螺帽工廠股份有限公司



_AD.[235]

HAUR FUNG ENTERPRISE

☉ External Tooth Washers, Long Carriage Bolts, Wood Screws, Machine Screws, Self-Tapping Screws, Self-drilling Screws, Chipboard Screws, Drywall Screws, Hexagon Head Bolts, Metal Washers, Long Bolts, Toothed Washers, a Variety of Nuts, Washers, Rivets ☉ Haur Fung established in 1988, is an exporter that specializes in hardware and screws. Haur Fung is the ideal supplier for attractive screws products customized to your needs.

☉ www.haurfung.com.tw
 ☉ henry@haurfung.com.tw
 豪航企業有限公司



_AD.[140]

HEADER PLAN CO. INC.

☉ Chipboard Screws, Wood Screws, TEK Screws, Self-drilling Screws, Machine Screws, Deck Screws, Collated Screws, Flat Head & Socket Head Cap Screws, High Low Thread Screws, Security Screws, Tapping Screws, Thread Cutting Screws, Spengler Screws Assembled with Washers ☉ Our head office in Taiwan handles all the inquiries and orders, and our factory is located in Vietnam. Production Capacity: 250 tons-300 tons per month. For all the shipment from our Vietnam factory to Europe: Anti-dumping duty: 0%

☉ www.headerplan.com.tw
 ☉ master@headerplan.com.tw



_AD.[245]

HO GUO ENTERPRISE

☉ Spring Washers, SEMS Screws, SEMS Washers, SEMS Spring Lock (M1.3~M16 SEMs Screw Washer), SEMs Spak (M3-M12), SEMs Spring (M1.3-M16), SEMs DIN 6905(M2.5-M12)

SEMS Spring Lock Washer JIS 1251, DIN 127B, DIN 7980, DIN 6905, IFI Socket, SPAK

ISO 9001 Certified

☉ www.fastener-world.com/en/supplier/hoguo
 ☉ hoguo.ent@msa.hinet.net
 合固企業股份有限公司



_AD.[167]

HO HONG SCREWS

☉ Button Head Cap Screws, Chipboard Screws, Open Die Screw, Alloy Steel Screws, Combined Screws, Metric Screws, Washer Head Screws, SEMs Screws (Captive Washer, DIN6905, DIN6907, Tooth Washer), Slotted Screws, EJOT Screws, Green Zinc Cr3 Screws, Nyplas Screws ☉ Ho Hong was established in 1980, and specialized in manufacturing SEMS screws. Our products are not only applied to domestic industries but also offered to all over the world.

☉ www.ho-hong.com.tw
 ☉ hohong67@ms49.hinet.net
 合鋒螺絲廠有限公司

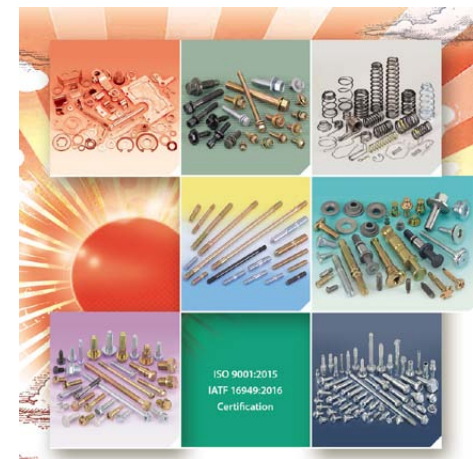

_AD.[438]

HOLD RICH INTERNATIONAL

☉ Screws & Nuts, Bolt, Brake System Parts, Valve Springs, Pressing Hardware Parts, Special Nuts, Flanged Head Bolts, Hexagon Head Bolts, Self-tapping Bolts, Combined Screws, Flange Screws, Flat Head & Socket Head Cap Screws, Weld Screws, Customized Special Screws / Bolts, Self-drilling Screws, Torx Drive System Screws, Countersunk Bolts, Cap Nuts ☉ We are a leading OEM & ODM of manufacturer & exporter of fasteners of automobiles & motorcycles in Taiwan.

☉ www.parts-holdrich.com
 ☉ holdrich@ms38.hinet.net
 鉉麒企業有限公司





_AD.[145]
HOME SOON ENTERPRISE

☉ Screwdriver Bits, Nut Setters, Bits, Socket Bits, Bit Holders, Bit Package, Bit Sets, Socket Sets, Sockets, Chuck / Adapter, Flexible Extension for Bits, Quick Release Flexible, Chuck ☉ Home Soon based in Taichung since 1982, is a leading manufacturer, preferred supplier and exporter of high-performance fastener tools serving the automotive, construction and industrial sectors in the world. We strive toward consistently high quality and prompt customer service in our operation.

☉ www.homesoon.com.tw
☉ home.soon@msa.hinet.net
宏舜企業股份有限公司



_AD.[294]
HONG YING FASTENERS ENTERPRISE

☉ High-tension Hexagon Socket Screws, Hexagon Socket Head Cap Screws, Hexagon Socket Countersunk Head Cap Screws, Hexagon Socket Button Cap Screws, Hexagon Socket Head Shoulder Screws, Hexagon Socket Headless Set Screws, Socket Pipe Plugs, Special Screws ☉ Hong Ying Fasteners Ent. Co., Ltd. is dedicated in "Hexagon Socket Screws, Screws, Fasteners, Bolts, Plugs, Alloy Steel, Allen Bolts, Metal Hardware" with operations in Taiwan.

☉ www.hongyingco.com.tw
☉ hong_ying@ms53.url.com.tw
虹瑩螺絲企業有限公司



_AD.[442]
HOPLITE INDUSTRY

☉ Fasteners in Construction, Electronic, Automotive; standard range of screws, rivets, bolts-nuts and washers in combination with setting equipment. We cover a variety of materials, heat treatments and plating, relating to different demands in specific markets. ☉ Hoplite Industry is a medium sized company with almost 20 years of experience in cooperating with a wide network of highly skilled manufacturers in fastener fields.

☉ www.hoplite.com.tw
☉ hoplite.ind@msa.hinet.net
合利國際股份有限公司



_AD.[264]
HOSHENG PRECISION HARDWARE

☉ Fiber-optic Telecommunications Equipment, Hydraulic/Pneumatic Components, Shafts, Mechanic Components, Electronic Components, Wire-cutting, Housing, Computer Connectors, Auto/Motorcycle Parts, Radio Wave Launchers, Radio Frequency Generators; Materials: Phosphor Bronze, Aluminum, Copper Beryllium, Free Cutting Copper, Stainless Steel ☉ We are a well-organized company, which is providing quality products under prompt lead-time.

☉ www.hosheng.com.tw
☉ ice.eilly@gmail.com
和昇工業社



_AD.[199]
HSIEN SUN INDUSTRY

☉ Hexagon Nuts, Tubular Nuts, Spacers, Anchors, Anchor Nuts, Acorn Nuts, Automotive Nuts, Bushing, Coupling Nuts, Lock Nuts, All Kinds of Screws, Weld Nuts ☉ Established in 1973, the ISO 9001 certified Hsien Sun Industry is one of the most experienced and specialized makers of nuts in Taiwan. Over the past 30 years, the company has grown into a supplier with a wide range of nut products, including conical/anchor nuts, anchors, special nuts, and various kinds of nuts.

☉ www.hsiensun.com.tw
☉ hsien.sun@msa.hinet.net
憲順工業有限公司



_AD.[137]
HSIN CHANG HARDWARE INDUSTRIAL

☉ Expansion Anchors, Wall Anchors, Wire Anchors, Ceiling Anchors, Nylon Nail Anchors, Anchors, Hammer Drive Anchors, Anchor Bolts, Construction Fasteners, OEM/ODM ☉ Situated in the middle of Taiwan, Hsin Chang Hardware has been manufacturing anchors series for 29 years. Led by the principles of professionalism, innovation, efficiency and reliable services, we have successfully developed a variety of new products that have been well received around the world.

☉ www.hsinchang.com.tw
☉ sales@hsinchang.com.tw
欣彰工業股份有限公司



SHM

HSIN HO MEI PLASTIC Co., Ltd.

Professional Production and Superior Service
Mold Design and Development/
Plastic Screws/Plastic Nuts/
Plastic Washers/Plastic Anchors/
Plastic Caps/Plastic Fasteners



_AD.[251]

HSIN HO MEI PLASTIC

☉ Plastic Screws, Plastic Nuts, Plastic Washers, Plastic Anchors, Plastic Caps, Plastic Fasteners
☉ Hsin Ho Mei was established in 1984 and has obtained ISO 9001 certification. We are professional in plastic mold designing and developing and plastic injection manufacturing. Our products are widely used in electronic components, server parts, auto parts, communication equipment, computer peripherals, household appliances, plastic fasteners, plastic parts.

☉ www.shmplastic.com.tw
☉ shm3715@ms69.hinet.net
鑫合美塑膠有限公司



_AD.[099]

HSIN HUNG MACHINERY

☉ Cap Nuts, Flange Nuts, Hexagon Nuts, Retaining Nuts, Self-locking Nuts, U Nuts, Prevailing Torque Nuts, Dome Nuts, Insert Nuts, Metal Nuts, Weld Nuts
☉ Founded in 1999, Hsin Hung led by the President with complete and professional experience, is a manufacturer specialized in Metal Insert Locking Nuts. Hsin Hung is probably the only one carrying out in-house spring-ring forming process.

☉ www.hsinhung.com.tw
☉ hhese988@ms49.hinet.net
欣翹股份有限公司



_AD.[039]

HSIN JUI HARDWARE ENTERPRISE

☉ Bushes, Construction Bolts, Special Cold / Hot Forming Parts, Automotive Parts, Special Parts, Spacers, Bushings, Sleeve Nuts, Gears, Special Cold Forming Parts for - Building Material - Automotive & Motorbikes - Bicycles - Ball Bearing Parts - Window Industry - Electrical Tools
☉ Hsin Jui Succeeds with 3 Critical Pillars. Cold forged automotive fastener expert having cold forging as its core manufacturing technology and laying stress on "speed, precision, and affordability" as its three success pillars.

☉ www.hsinjui.com.tw
☉ service@hsinjui.com.tw
欣瑞五金企業有限公司



_AD.[194]

HSIN YU SCREW ENTERPRISE

☉ T-head or T-slot Bolts, U Bolts, Acme Screws, Hexagon Head Cap Screws, Knurled Head Screws, Thumb Screws, Zinc Plated, High Low Thread Screws, Hose Clamp Screws, Double Lead Thread Screws, Furniture Screws, Shoulder Screws
☉ Hsin Yu has a team of professional and experienced technicians, together with ISO 9001 quality regulation. Quality is aiming toward zero defects.

☉ www.u-teck.com.tw
☉ hyus@ms11.hinet.net
新雨工業股份有限公司



_AD.[040]

HU PAO INDUSTRIES

☉ Automotive Nuts, Flange Nuts, Hexagon Nuts, Square Nuts, Weld Nuts, Wheel Nuts, Spacers, Prevailing Torque Nuts
☉ HU PAO company's focus is to offer high quality and good service to our customers. We are one professional manufacturer for all kinds of flange nut & roller and special products, and have 23 years of experience in the technology of producing special nuts. You're welcome to send your drawing or samples.

☉ www.fastener-world.com/en/supplier/hupao
☉ hupao@hupao.com.tw
如保興業股份有限公司



_AD.[305]

HUANG JING INDUSTRIAL

☉ Chipboard Screws, Drywall Screws, PVC Screws, Bi-metal Screw, Self-drilling Screws, PT Screws, Deck Screws, Wood Screws, A2 Cap Screw, Iron Or Steel Wire Rod, All Kinds of Screws
☉ HUANG JING is a manufacturer and export company specializing in fasteners. The main range of our supply includes a variety of screws, nuts and other relevant types of fastening parts. We can assure quality not only by ourselves but also by independent laboratory as per clients' request.

☉ www.fastener-world.com/en/supplier/huang-jing/
☉ huang.jing@msa.hinet.net
皇晉工業有限公司





_AD.[094]
HWA HSING SCREW INDUSTRY

☉ Chipboard Screws, Drywall Screws, Furniture Screws, Wood Screws, Self-drilling Screws, Collated Screws, Deck Screws, Self-Tapping Screws, Concrete Screws, Machine Screws, Special Screws, Roofing Screws ☉ Our company established in 1973. We have 150 sets of machines that can produce products in M2.5~M10, length 10~400mm; 3 sets of continuous heat treatment, and speed packing machines specialized for Bulk, Small boxes and Collated and DIY.

☉ www.hwahsing.com
☉ hhs@hwahsing.com
華興工業股份有限公司



_AD.[295]
HWAGUO INDUSTRIAL FASTENERS

☉ Spring Pins, Cage Nuts, U Nuts, Rivets, Lock Washers, Clip Nuts, Blind Nuts / Rivet Nuts, Multi-die Forming Fasteners, Cap Nuts, Special Washers, Springs, Spring Steel Fasteners: Retaining Rings (Ext & Int), Tooth Lock Washers, Clip, Push Washers, Push Nuts, Cage Nuts, E-Rings, All Kinds of Washers, Nuts & Special Stamping Parts ☉ Hwaguo Industrial was established in 1977. We always serve our customers with our excellent quality, competitive price and punctual delivery.

☉ www.hwaguo.com
☉ sales@hwaguo.com
華國五金有限公司



_AD.[065]
HWALLY PRODUCTS

☉ Chipboard Screws, Anchors, Concrete Screws, Wedge Anchors, Sleeve Anchors, Hollow Wall Anchors, Metal Insulation Plugs, Expansion Anchors, Drop-in Anchors, Nail In Anchors, Nylon Nail Anchors, Speed Anchor Zinc Alloy ☉ With 40 years of experience in Wall Anchor manufacturing since 1980, Hwally products has been supplying quality wall anchors in all shapes and sizes and fixing systems to buyers in the US, Europe, Japan, Australia and other areas.

☉ www.hwally.com.tw
☉ hwally@hwally.com.tw
樺麟企業有限公司



_AD.[198]
HWEI NEN CO., LTD.

☉ Custom Bolts, Automotive & Motorcycle Special Screws / Bolts, Automotive Screws ☉ Hwei Nen was established in 1990 and dedicates itself to becoming the best partner for its customers with the vision of "pursuing the finest quality and on-time delivery" while rooting in Taiwan and extends to the overseas market with reasonable cost and innovative manufacturing techniques.

☉ www.fastener-world.com/en/supplier/hne/
☉ andrew.chenhne@msa.hinet.net
輝能工業股份有限公司



_AD.[285]
INDUSTRY BUILDING HARDWARE (IBH)

☉ Cap Screws, Button Head Socket Cap Screws, Chipboard Screws, Collated Screws, Concrete Screws, Construction Fasteners, Bonded Washers, Deck Screws, Drywall Screws, Lag Screws, Roofing Screws, Self-drilling Screws ☉ Industry Building Hardware (IBH) has more than 20 years of experience in the fastener field, we are a professional screw manufacturer and export company dealing with all connecting parts.

☉ www.ibh-fastener.com.tw
☉ ritasu@ibh-fastener.com.tw
和驛國際有限公司



_AD.[085]
INMETCH INDUSTRIAL

☉ Flanged Head Bolts, Stud Bolts, Shoulder Screws, Bushings, Acme Screws, Automotive & Motorcycle Special Screws / Bolts, OEM/ODM, Nylon Cap Insert Lock Nuts, All Kinds of Nuts, Cold Forged Nuts ☉ INMETCH has been established as professional and experienced in the industry for decades, serving the high-end market for fasteners applications. We are dedicated to the innovative products for the most customers such as automotive and construction users.

☉ www.inmetch.com
☉ im@inmetch.com.tw
恆鉅國際股份有限公司





_AD.[084]

INNTech INTERNATIONAL

● Ball Ended Screws, Turning Parts, Sinter Parts, Die Casting, Automotive & Motorcycle Special Screws / Bolts, All Kinds of Screws, All Kinds of Nuts, Special Cold / Hot Forming Parts, Open Die Screws, Forged and Stamped Parts, Sintered Powder Metal Parts, CNC Machining Parts ● Inntech is a trading & engineering service in Taiwan, we base on "Innovation and Technology", our growing essence. We approach our customers and suppliers as long-term partners, to work together to achieve shared goals.

● www.inntech.com.tw
 ● iinntech.tw@msa.hinet.net
 建豪國際股份有限公司



_AD.[172]

J. T. FASTENERS SUPPLY

● Blind Nuts / Rivet Nuts, Weld Nuts, Self-clinching Nuts, Special Nuts, Insert Nuts, Automotive & Motorcycle Special Screws / Bolts, Brass Insert, Special Parts, Blind Rivet Studs, Clinch Studs, Forged And Stamped Parts, Stamped Parts ● J.T. Fasteners Supply Co., Ltd. is one of the renowned manufacturers, suppliers and exporters of Fasteners. With years of experience in the line of making, we are known for our outstanding performance in the industry.

● www.jtfasteners.com.tw
 ● jimmy@jtfasteners.com.tw
 金祐昇實業有限公司



_AD.[010]

J.C. GRAND CORPORATION

● Drywall Screws, Self-drilling Screws, Self-Tapping Screws, Color-coated Screws, SEMS Screws, Stainless Steel Screws, High Low Thread Screws, Multi-stage Screw & Parts, Thread Cutting Screws, Chipboard Screws, Special Screws, All Kinds of Screws ● JC Grand is a manufacturer and exporter of industrial fasteners and metal hardware components. Since 1978, JC Grand has been serving customers globally with high quality screws, nuts, bolts, washers, anchors, and customized hardware.

● www.jcgrand.com
 ● sales@jcgrand.com
 俊良貿易股份有限公司



_AD.[058]

JAU YEOU INDUSTRY

● Chipboard Screws, Drywall Screws, High Low Thread Screws, Self-drilling Screws, Taptite Screws, Hexagon Washer Head Screws / Bolts, SEMS Screws, Wood Screws, Tapping Screws, Automotive Screws, Multi-stage Screws & Parts ● To satisfy our customers, we supply great products, deliver them on time and deal quickly with any questions and problems for our customers. We will continue to expand our service to ensure beneficial business with our customers.

● www.jauyeou.com
 ● jau@ms10.hinet.net
 朝友工業股份有限公司



_AD.[034]

JET FAST COMPANY

● Blind Nuts / Rivet Nuts, Others ● Founded in 1979 in southern Taiwan, Jet Fast is a professional manufacturer in Blind Fasteners with IATF16949 and ISO 9001 certificates. We carry more than 500 items in different sizes and material such as Rubber/Nylon Nut-Insert and Metal Rivet Nut in our warehouse with speedy service to facilitate customer's requirement. Our products are mainly used on automotive, industry and DIY market.

● www.jetfast.com.tw
 ● jetfast@ms34.hinet.net
 捷禾企業有限公司



_AD.[363]

JGB INDUSTRIAL INC.

● Precision Metal Parts, Shoulder Screws, Dowel Pins, Thumb Screws, Thumb Nuts, Brass Insert, Turning Parts, Milled Bolts, Milled Nuts ● JGB is an ISO 9001 manufacturer who produces precision fasteners, hardware, machinery components, etc. Our major materials are in Stainless Steel, Alloy Steel, Special Bronze or special materials. CNC turning parts and cold forming after CNC turning fix are most usually parts. We invite you to take a virtual tour of our facilities.

● www.jgb.tw
 ● info@jgb.tw
 金城工業有限公司





_AD.[227]
Ji LI DENG FASTENERS

• Washers and Pressed Parts, Plastic & Nylon Fasteners, Special / To Drawing Fasteners, Turned Parts, Fastener Assemblies and Combinations, Studs, Threaded Rods, Cold Forged Fasteners and Parts, Automotive Screws, Appliance Screws, CNC Machining Parts, Alloy Steel Screws, Weld Screws, Machine Bolts, PT Screws, SEMS Screws, Double-head Screws / Bolts, OEM/ODM, Thread Forming Screws • Ji Li Deng supplies Customized Parts, Stamping, Plastic Fasteners, CNC, etc.

• www.jldfasteners.com.tw
• sales@jldfasteners.com.tw
吉立登實業有限公司



_AD.[057]
JiEN KUEN ENTERPRISE

• Round Weld Nuts, Flange Weld Nuts, Special Nuts, Nylon Lock Nuts, Hex Weld Nuts, Square Nuts, Square Weld Nuts, Hex Nuts
• We specialize in manufacture of various nuts.

• www.fastener-world.com/en/supplier/jnkun
• eileen.jnkun@msa.hinet.net
健坤企業股份有限公司



_AD.[124]
JIN SHIN CHYUAN INDUSTRY

• Clinch Nuts, Dome Nuts, Hexagon Nuts, Hexagon Head Cap Screws, Brass & Bronze Screws, Carbon Steel, Fastener Kits, Bushes, Turning Parts, Bushings, Automotive & Motorcycle Special Screws / Bolts, Carbon Steel Screws • We process all stationery Goods* Hardware Parts* Electronic Connectors and Gifts & Promotional Items. We started the business as a manufacturer of various hardware parts & fasteners in 1978.

• www.jinsc.com.tw
• jam@jinsc.com.tw
金欣全精密工業股份有限公司



_AD.[304]
JIN SHING STAINLESS IND.

• Self-Tapping Screws, Machine Screws, Chipboard Screws, Wood Screws, Taptite Screws, Plastite Screws, Self-drilling Screws, Collated Screws, Thread Forming Screws, High Low Thread Screws, PT Screws, Drywall Screws, Furniture Screws, Electronic Screws...etc. • Jin Shing wishes to be your screw and fastener manufacturing foundry in Asia, where you can purchase all screw and fastener products at one stop. You can easily contact us for product information through email or skype.

• www.jinshing.com.tw
• sales1@jinshing.com.tw
竣鑫工業股份有限公司



_AD.[196]
JINGFONG INDUSTRY

• Automotive Nuts, Flange Nuts, Square Nuts, Conical Washer Nuts, Nylon Cap Insert Lock Nuts, Flange Nylon Nuts With Washers, Prevailing Torque Nuts • JingFong, a lock nuts specialist, was founded in 1980. Today, JingFong is actively supplying various nuts to customers in Asia, Europe, North and South America. The total sales can be organized into two major product categories serving a broad spectrum of markets: Engineered Standard Fasteners

• www.jingfong.com.tw
• sales@jingfong.com.tw
璟鋒工業股份有限公司

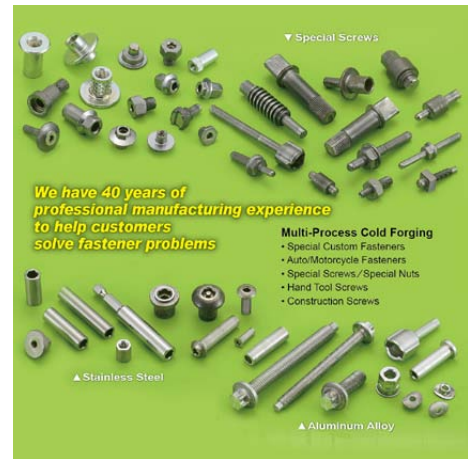

_AD.[249]
JIN-YINGS ENTERPRISE

• Special Nuts, Stainless Steel Fasteners, Stainless Sleeves, Special Automotive Fasteners, Special Screws, Automotive & Motorcycle Special Screws / Bolts, Hexagon Head Cap Screws, Hexagon Washer Head Screws / Bolts, High Low Thread Screws, Socket Head Cap Screws, Wood Screws, Drop-in Anchors • With more than 30 years of bountiful experiences, technical expertise, we continuously invest in a variety of precise production equipment and testing equipment.

• www.jin-yings.com.tw
• jin-yings@hotmail.com
晉營實業股份有限公司





JOINER FASTENER ENTERPRISE

☉ Chipboard Screws, Drywall Screws, Bi-metal Screws, Roofing Screws, Self-drilling Screws, Machine Screws, Concrete Screws, Self-Tapping Screws, Stainless Steel Screws, Customized Special Screws / Bolts, Collated Screws, Cap Screws, Screws for Plastic Board, Window Building Screws, Special Coating Screws ☉ Joiner Fastener is a specialized screw manufacturer in Taiwan, with management principle of sincerity, efficiency and reliability to serve our customers worldwide.

☉ www.joiner-fastener.com.tw
 ☉ anthony@joiner-fastener.com.tw
 喬亞股份有限公司



_AD.[049]

JOKER INDUSTRIAL

☉ Hollow Wall Anchors, Concrete Screws, Jack Nuts, Express Nails, Easy Anchors, Metal Insulation Plugs, Concrete Nails, Sleeve Anchors, Metal Frame Anchors, Safety Nail Anchors, Express Hangers, Construction Fasteners ☉ Joker, a screw anchor fastener and fixing manufacturer has been specialized in building anchor for 35 years with more than 90% export to Europe. In 2014, we were the first Taiwanese concrete screw manufacturer approved by the ETA Option 1 certificate.

☉ www.joker.com.tw
 ☉ info@joker.com.tw
 久可工業股份有限公司



_AD.[244]

KAO WAN BOLT INDUSTRIAL

☉ Hexagon Head Bolts, Hexagon Head Cap Screws, Hex Heavy Bolt, High Strength Hexagon Bolts, Stud Bolts, Welding Studs, Machine Screws, Foundation Screws, Carriage Bolts, Lag Bolts, Self-Drilling Screws, Expansion Screws, Tapping Screws, Hexagon Nuts, Hex Heavy Nut, Forged Hexagon Nuts, Flat Washer ☉ Established in 1978, Kao Wan is the largest screw supplier of the domestic market in Taiwan, with more than twenty thousand tons of products in stock and the most complete product range and specifications.

☉ www.kaowan.com.tw
 ☉ daphne_wu@kaowan.com.tw
 高旺螺絲工業有限公司



_AD.[149]

KARAT INDUSTRIAL

☉ Plastic Rivets, Blind Nuts / Rivet Nuts, Blind Rivets, Tool Kits, Blind Rivet Studs, Hand Rivet Tools, Hand Rivet Nut/Rivet Bolt Tools, Air Hydraulic Rivets, Lock Bolt Tools, Air Hydraulic Riveters, Air Hydraulic Rivet Nut Tools, Hand Riveters ☉ KARAT Industrial is a Professional Manufacturer of Riveters & Rivet Nut Tools in Taiwan since 1982. We have strong R&D ability, reliable production, strict QA system, and fast after-sales service. KARAT Tools are 100% Made in Taiwan.

☉ www.KaratTool.com
 ☉ Sales@KaratTool.com
 寶資工業股份有限公司



_AD.[120]

KATSUHANA FASTENERS

☉ Screws, TEK Screws, Thread Cutting Screws, Roofing Screws, Self-drilling Screws, Collated Screws, Drywall Screws, Twinfast Woodscrews, Deck Screws, Particle Board Screws, Chipboard Screws, Thread Rolling Screws, SMS-Tapping Screws, Masonry Screws, Set Screws, Concrete Screws, Furniture Screws, Wood Screws, Machine Screws, Multi-Stroke Screws, Open Die Screws, Nails, SEMs Screw, Stainless Steel ☉ Katsuhana is a leading manufacturer in Taiwan, specialized in fasteners & fittings.

☉ www.katsuhana.com.tw
 ☉ khn.begin@msa.hinet.net
 濱井企業股份有限公司



_AD.[211]

KENT SCREWS

☉ Automotive Nuts, Hexagon Head Bolts, Lag Bolts, Flat Head & Socket Head Cap Screws, Furniture Screws, Hexagon Head Cap Screws ☉ 30 years of experience in fasteners & component parts. Screws are made according to ISO, DIN, BS and ANSI Standards; Hinges for Furniture, Stereo, Glass Doors and Cabinet Doors, Self Closing Cabinet Hinges.

☉ www.fastener-world.com/en/supplier/kentco
 ☉ fytony@ms22.hinet.net
 肯特螺絲有限公司





_AD.[163]
KEY-USE INDUSTRIAL WORKS

☎ Flanged Head Bolts, Milled Bolts, Rim Bolts, Round Head Bolts, Square Head Bolts, T-head or T-slot Bolts, Track Bolts, Weld Bolts (studs), Wheel Bolts, Shoulder Bolts, Special Bolts ☎ Key-Use is a professional manufacturer that began in 1987. We have more than two decades of experience in fastener area. We specialize in the production of bolts and hardware. We constantly improve technology and facilities, making us a leader in market development.

☎ www.keyuse.com.tw
☎ sales@keyuse.com.tw
凱雍工業股份有限公司



_AD.[301]
KING CENTURY GROUP

☎ Drop-in Anchors, Self-drilling Anchors, Sleeve Anchors, Ceiling Anchors, Nylon Nail Anchors, Hammer Drive Anchors, Hollow Wall Anchors, Metal Frame Anchors, Anchors, Expansion Anchors, Wedge Anchors ☎ King Century was founded in 1991 in Taichung, Taiwan. We decided to start a factory- KINKU Fastener System Co., Ltd. in 2001 in Ningbo, China. The factory is 12,000 square meters and has more than 150 employees.

☎ www.fastener-world.com/en/supplier/king-c
☎ jeffrey@king-century.net
慶宇國際貿易有限公司



Color Ring Bits with Magnet Holders



_AD.[370]
KING HO CHANG CO., LTD.

☎ Professional Bits, Standard Bits Sets, Color Ring Bits Sets, Color Ring Torsion Bits Sets, Color Ring Stainless Bits Sets, Extractor Sets, Mini Sets, Torque Ratchet Screwdriver Sets, Bulks, Screwdriver Bits, Precision Bits, Sockets, Ratchets ☎ King Ho Chang was established in 1995. Our persistence on quality can be seen through our custom-made CNC machineries, up-to-date testing equipment and extensive training for the employees.

☎ www.khc-bit.com.tw
☎ info@khc-bit.com.tw
金禾昌有限公司



KO YING HARDWARE INDUSTRY

☎ Motorcycle Fasteners, Automotive Fasteners, Construction Fasteners, Furniture Fasteners, Custom Fasteners (Drawing Fasteners), Technique and Design ☎ KO YING was established in 1997. One of our strengths is to develop and research fasteners from the customers' drawings or samples to meet their needs. We are a customer-oriented company. It is our policy to produce high quality and customized products that satisfy our customers' expectations in order to do so, we have an R&D Department. We are already certified to ISO:9001.

☎ www.ko-ying.com.tw
☎ koying@koying.com.tw
柯穎五金企業有限公司



_AD.[225]
KUNTECH CORPORATION

☎ CNC Machining, Cold-Forming ☎ Kuntech devotes to the areas of customized fasteners and precise machining hardware since its establishment. Upholding the spirit to serve the customers and to meet the market demands, we have been deeply into the industries for nearly two decades. With high precision and multi-functional CNC hybrid machinery, we can almost satisfy all the demands from the customers.

☎ www.kuntech.com.tw
☎ info@kuntech.com.tw
鉅堃國際股份有限公司



_AD.[074]
KWANTEX RESEARCH

☎ Chipboard Screws, Drywall Screws, Furniture Screws, Wood Screws, High Low Thread Screws, Roofing Screws, Self-drilling Screws, Machine Screws, Twinfast Woodscrews, Collated Screws, Deck Screws ☎ Kwantex Research Inc. was established since 1996 mainly devoting to Research and Design in the fastener field. We are one of the few enterprises who owns the most fastener patents and collaborates with many outstanding fastener companies over the world on innovative products.

☎ www.kwantex.com.tw
☎ kwantex@ms18.hinet.net
寬仕工業股份有限公司





_AD.[108]

L & W FASTENERS

Flat Washers, Lock Washers, Hexagon Nuts, Hexagon Head Bolts, Long Carriage Bolts, Socket Head Cap Screws, Socket Head Set Screws, Heavy Nuts, Large Diameter Bolts, Large Nuts, Prevailing Torque Nuts, Construction Fasteners

L&W is a professional fastener supplier of construction, machines and general industry. We work with more than 250 subcontract makers in Taiwan, China, Korea and Thailand.

www.lwfasteners.com.tw
king-lin@lwfasteners.com.tw
金大鼎企業有限公司



_AD.[173]

LIAN CHUAN SHING INTERNATIONAL

Weld Nuts, Special Parts, Carbon Steel Washers, Custom Washers, Flat Washers, Special Size Washers, Lock Washers, Cage Nuts, CNC Machining Parts, Tubes, U Nuts, Tee or T Nuts

Lian Chuan Shing founded in 1996, specializes in the manufacturing of stamping parts, such as washers, nuts, tubes, special parts, custom parts, and assembling parts. Our products are used in the automotive industry, home appliance, furniture, machinery as well as building hardware.

www.lian-chuan-shing.com.tw
sales@lian-chuan-shing.com.tw
連全興國際有限公司



_AD.[177]

LINK-PRO TECH

Blind Nuts / Rivet Nuts, Custom Pins, Threaded Nails, Custom Washers, Automotive Parts, Forged And Stamped Parts, CNC parts, CNC Lathes, Special Parts, Socket Set Screws, Customized Special Screws / Bolts, Cage Nuts, Nylon Nuts With Conical Washers

Established: 2015; Quality System: ISO 9001; Products: Customized fastener / Assembly Component; Materials: aluminum, brass, copper, stainless, carbon, alloy steel, high strength alloy, plastic, rubber.

www.lpt.com.tw
sales@lpt.com.tw
超傑實業有限公司



_AD.[456]

LINKWELL INDUSTRY

Flat Washers, Castle Nuts, Weld Nuts, Weld Screws, Triangular Thread Screws, High Low Thread Screws, Self-drilling Screws, All Kinds of Screws, Automotive & Motorcycle Special Screws / Bolts, Chipboard Screws, SEMS Screws, Conical Washer Nuts

Linkwell was established since 1977. We manufacture & export all kinds of fasteners covering bolts, screws, nuts, washers, pins, rivets, anchors and threaded rods & stud bolts, stamping parts, either ferrous or non-ferrous materials.

www.linkwell.com.tw
service@linkwell.com.tw
順承企業股份有限公司



_AD.[012]

LOCKSURE INC.

Automotive Screws, Automotive Nuts, Flange Nuts, Weld Nuts, Weld Bolts (Studs), Turning Parts, Automotive Parts, Special Parts, Stamped Parts, CNC parts, CNC Lathes, Special Cold / Hot Forming Parts, Stainless Steel Nuts

Founded in 1984, Locksure has been a leading special parts supplier in the fastener industry. Product ranges from special cold formed parts to parts with secondary operation & assembly. Locksure was IATF 16949 certified.

www.locksure.com.tw
qksu@locksure.com.tw
今湛企業股份有限公司



_AD.[045]

LONG THREAD FASTENERS

Bi-metal Self-drilling Screws, Chipboard Screws, Drywall Screws, Recessed Head Screws, High Low Thread Screws, Roofing Screws, Self-drilling Screws, Machine Screws, PT Screws, Particle Board Screws, Self-Tapping Screws, Special Screws, Self Drilling Type "17" Screws, Masonry Screws, Nail Screws

www.fastener-world.com/en/supplier/longthread
lothread@ms33.hinet.net
長隆順股份有限公司





LONGHWA SCREW WORKS

• Chipboard Screws, Washer Head Screws, Wood Screws, Self-drilling Screws, Concrete Screws, Countersunk Screws, Drywall Screws
 • As a professional manufacturer, we place heavy investment in our quality control. Screws are tested during every process of the production with precise measuring equipments. Inspection guidelines are followed strictly to ensure our quality meets international standards. Long Hwa continues to insist on stable quality and customer satisfaction.

• www.long-hwa.com.tw
 • longhwa.putz@msa.hinet.net
 隆華螺絲工廠股份有限公司



_AD.[105]

LOYAL & BIRCH®

• Construction Fasteners, Self-Tapping Screws, Chipboard Screws, Self-drilling Screws, Collated Screws, Concrete Screws, Carbon Steel Screws, Drywall Screws, High Low Thread Screws, Color-coated Screws, Tapping Screws, Wood Screws
 • Focus on mainly construction screws and connectors, with applications from foundation to framework, and from concrete, steel to wood. We also work with global brands of power tools for its collated fasteners.

• www.fastener-world.com/en/supplier/loyalbirch
 • sales@loyalbirch.com
 龍業百起股份有限公司



_AD.[097]

MAC PRECISION HARDWARE

• Turning Parts, Automotive Parts, CNC parts, CNC Lathes, Hydraulic Components, Machine Parts, Stamped Parts, Special Parts, Special Cold / Hot Forming Parts, Forged and Stamped Parts
 • MAC Precision Hardware located in Kaohsiung, Taiwan, a branch of MAC Group, offers our worldwide customers efficient communication and sales service. We are a manufacturer of special turning/milling parts and looking for long term partners. We have 40-year experience in producing turning parts.

• www.machardware.com.tw
 • service@machardware.com.tw
 鑫瑞精密工業有限公司



_AD.[258]

MAO CHUAN INDUSTRIAL

• Custom Washers, Cage Nuts, U Nuts, J Nuts, Forged And Stamped Parts, Automotive Parts, Galvanized Washers, Stainless Steel Fittings, Stainless Steel Washers, Phosphor Bronze Washers, Weld Nuts
 • Mao Chuan is specialized in sheet metal stamping with more than 50 years of experience in automotive, electronic and construction field. Certified to IATF 16949, ISO 9001, ISO 14001 and VDA6.1.

• www.maochuan.com.tw
 • maochuan@maochuan.com.tw
 貿詮實業有限公司



_AD.[026]

MASTER UNITED CORP.

• Chipboard Screws, Drywall Screws, Furniture Screws, Washer Head Screws, Wood Screws, Roofing Screws, Self-drilling Screws, Taptite Screws, Machine Screws, Construction Fasteners
 • Master United is a leading manufacturer of fasteners for more than 30 years. We produce top quality screws, fasteners, hardware and other related products. Our factory "Anjifast" in China is capable of producing 3000 tons of screws per month and "Bonuts" is specialized in DIY products and packaging.

• www.muc.com.tw
 • info@muc.com.tw
 永傑實業有限公司



_AD.[372]

MAUDLE INDUSTRIAL

• Button Head Socket Cap Screws, Flange Washer Head Screws, Hexagon Head Cap Screws, Flat Head & Socket Head Cap Screws, Customized Special Screws / Bolts, SEMS Screws, Socket Head Cap Screws, Socket Set Screws, Machine Screws, Shoulder Screws, Screws in small packs, Metric Screws
 • Maudle (TUZ) established in 1987, is located in Taiwan. TUZ is dedicated to supplying a wide range of hex socket screws in materials from high strength alloy steel, carbon steel to stainless steel.

• www.tuz.com.tw
 • sales@tuz.com.tw
 茂興實業股份有限公司





_AD.[238]

MAXTOOL INDUSTRIAL

● Plastic Screws, Drop-in Anchors, Expansion Anchors, Wall Anchors, Nylon Nail Anchors, Conical Plastic Anchors, Pvc Extruded Plastic Plugs, Set Anchors, Easy Anchors, Anchors, Wood Screws, All Kinds of Screws ● Maxtool was founded in 1987 for manufacturing OEM/ODM parts, hand tools and assorted hardware parts. We have our own R&D department, responsible for fulfilling our worldwide marketing requirements.

● www.maxtool.com.tw
 ● service@maxtool.com.tw
 系格工業股份有限公司



MEJOR FASTENER SUPPLY

● Precision Electronic Screws, OEM/ODM, Self-clinching Nuts, CNC parts, CNC lathe, Turning Parts ● We are a manufacturer of CNC parts, SMA connectors, and Electronic Hardware, such as male-male standoffs, male-female standoffs, female-female standoffs, spacers, jackscrews, precision shoulder screws, thumb screws, and so on. Our shop is not in big cities. Instead, we choose to be in countryside to minimize all the expenses and to be competitive enough to others. Try us, you will know that we are not only good at quality, but also at price and delivery.

● www.mejorfastener.com
 ● sales@mejorfastener.com
 承品精密有限公司



_AD.[018]

MIN HWEI ENTERPRISE

● Button Head Socket Cap Screws, Chipboard Screws, Drywall Screws, Flat Head & Socket Head Cap Screws, Sheet Metal Screws, TEK Screws, Machine Screws, Deck Screws, Hex. Socket Cap Screws, Carriage Bolts ● Min Hwei was established on 1994 as a leading professional stainless steel screws manufacturer. We offer the products all the world in excellent quality and efficient service to meet customers requests.

● www.minhwei.com.tw
 ● export@minhwei.com.tw
 明徽企業股份有限公司



_AD.[221]

MING CHENG PRECISION

● Precision Auto Parts, Precision Shafts, RF and Optical Fiber Connectors, Precision Milling Parts, Hydraulic Parts, Precision Valves, High-end Bike Parts ● Established in 1984, Ming Cheng Precision Co., Ltd. is located in Pu Yan village in Chuanghua County of Taiwan and commits itself as a well-known CNC automated machining company that always keeps technology, service and customers above everything to offer satisfactory business commitment and work hard for a brighter future.

● www.ming-cheng.com.tw
 ● info@ming-cheng.com.tw
 銘承精密工業股份有限公司

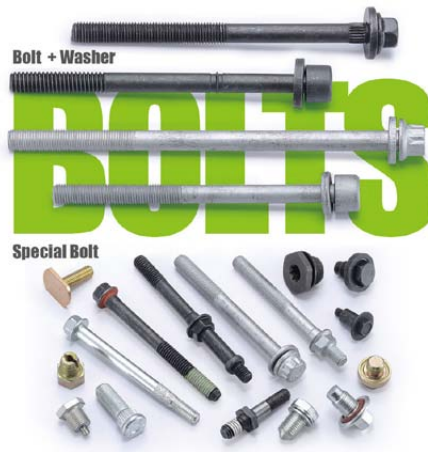

MIT INDUSTRIAL ACCESSORIES MECHANICAL HARDWARES

● Screw Plugs, All Kinds of Nuts, All Kinds of Screws, Stamped Parts, CNC Machining Parts, Customized Special Screws / Bolts, Lug Nuts, Special Lug Nuts ● Mechanical Hardwares has been exporting Cold Forged since 1985. We get great reputation for our Strong Production Facility, Good Parts Quality and Competitive price for our customers. Try us and you will be satisfied with our offers.

● www.mhardware.com
 ● mitind.parts@msa.hinet.net
 術威企業有限公司



MODERN ALLOY PLATING

● Zinc Plated, Lubricant, Electro Plating, Trivalent Zinc Nickel Plating, Trivalent Zinc Iron Plating, Acid Zinc Plating, Mechanical Plating, E-Coating ● Established in 2005, Modern Alloy Plating Co., Ltd. mainly provides surface treatment such as Electrocoating, Zinc-Nickel Alloy Plating, Zinc-Iron Alloy Plating, Acid Zinc Plating, Mechanical Zinc Galvanizing, and Electrolysis Polishing for High-Corrosion Resistance Stainless Steel and other applications.

● www.mapt.com.tw
 ● info@map.com.tw
 頂吉興科技股份有限公司





_AD.[233]
MOHINDRA FASTENERS (MFL)

☎ Standard/Norm Parts, Parts by Drawing and Automotive Parts ☎ Mohindra Fasteners Ltd (MFL), a public Limited Company based out of India, started its commercial production in the year 1997. Over the years, it has successfully emerged as a name to reckon within the Indian fastener industry. The company has made major in-roads into the Export markets of Europe and USA. The company offers a wide range of cold and hot forged fasteners and other precision machined components for automotive and Industrial applications in the diameter range from 3mm to 78mm.

☎ www.mohindra.asia
☎ info@mohindra.asia



_AD.[195]
MOLS CORPORATION

☎ Sheet Metal Screws, Triangular Thread Screws, Roofing Screws, Self-drilling Screws, Taptite Screws, Wood Screws, Appliance Screws, Construction Fasteners, Self-Tapping Screws, Security Screws, Screws in small packs, Thread Forming Screws, Home Appliance and Customized Screws, OEM/ODM ☎ MOLS is a professional screw manufacturer in Taiwan who specializes in offering various types of screws. We have our own screw factory, heat treating plant and painting factory.

☎ www.molscorp.com
☎ mols@molscorp.com
冠鑫貿易股份有限公司



_AD.[048]
MOUNTFASCO INC.

☎ Automotive Screws, Bolts, Dowel Pins, Solid Rivets, Ball Ended Screws, All Kinds of Screws, Alloy Steel Screws, Automotive & Motorcycle Special Screws / Bolts, Carbon Steel Screws, Connecting Rod Bolts, Construction Bolts, Custom Bolts ☎ Mountfasco is the manufacturing company of screw related products for automotive industry. Meeting the requirements of customers and on time delivery are our faith and basic requirement. We'll keep our words: Stable quality and on time delivery.

☎ www.mountfasco.com.tw
☎ mfc.ft@msa.hinet.net
崎鈺企業股份有限公司



NCG TOOLS

SWIVEL HEAD AIR-HYDRAULIC RIVETING TOOL SHAR100 Series

COMPACT RIVETING TOOL HF300 Series

DRILL ATTACHMENT AU100 Series

THE RIVETING EXPERT

_AD.[150]
NCG TOOLS INDUSTRY

☎ Blind Rivets, Tool Kits, Blind Rivet Studs, Anchors, Plastic Rivets, Blind Nuts / Rivet Nuts, Air Tackers/ Air Staple Guns / Air Nailing Tools, Electric Staple Guns, Hand Tools ☎ Founded in 1978, NCG Tools has been designing and manufacturing professional riveting and fastening tools. NCG Tools is the first to design patented innovations such as 360 degree Rotating Head Riveters, Heavy Duty Folding Handle Riveting Tools, Multi-Function Riveting Tools and Drill Attachment Tools.

☎ www.ncgtools.com
☎ ncg@ncgtools.com
昶彰工業股份有限公司



ND Your Fastener Solution

Product Range: M2-M25 in Diameter 2mm-200 in Length

_AD.[052]
ND INDUSTRIES ASIA

☎ Automotive Nuts, Barrel Nuts, Blind Nuts / Rivet Nuts, Weld Nuts, Flanged Head Bolts, Flange Screws, Bushes, Bushings, Anchor Bolts, Screws And Nuts Locking And Sealing Process ☎ Since 1955 ND Industries has been providing top quality fastening and assembly related products and services to a wide variety of industries including automotive, electronics, aerospace, appliance, and many more.

☎ www.ndindustries.com
☎ nhsieh@ndindustries.com
穩得工業股份有限公司



NEWFAST / NEWPACK

☎ Triangular Thread Screws, Twinfast Woodscrews, Washer Head Screws, Thread Rolling Screws, Thread Forming Screws, Thread Cutting Screws, TEK Screws, Tapping Screws, Tamper-proof Screws, Machine Screws, Multi-die Forming Fasteners, OEM/ODM ☎ NEWFAST has 30 years of fastener experiences, supported by sister company NEWPACK, to provide a comprehensive product line as well as one-stop service to customers.

☎ www.newfast.com.tw
☎ sales@newfast.com.tw
峻拓股份有限公司





_AD.[230]
NORM CIVATA

☉ Wheel Bolts, Studs, Six & Twelve Lobe Parts, Hexagon And Hexalobular Head Bolts And Screws, Hexagon And Hexalobular Socket Head Cap Screws, Cup Head Square Neck Bolts, Flange Bolts, Special Weld Bolts, Special Rivets, Inch Sizes, Round Weld Nuts, Square Weld Nuts, Prevailing Torque Type Hexagon ☉ NORM CIVATA, leading manufacturer and exporter of steel bolts and nuts in Turkey, is a unique company that produces customized & standard Bolts & Nuts for Automotive & many other industries.

☉ www.normholding.com
☉ okan.uybat@norm-fasteners.com.tr



_AD.[256]
NOVA. FASTENER

☉ Hexagon Nuts, Square Nuts, Wood Screws, Self-drilling Screws, Machine Screws, Stainless Steel Screws, Concrete Screws, Construction Fasteners, Chipboard Screws, Roofing Screws, Stainless Steel Hex Nuts, Stainless Steel Nuts, Long-size Screws, Automatic Products, Nuts ☉ Nova. Fastener is located at Kangshan District in south Taiwan. We are a professional, experienced fastener supplier, and cooperate with customers to develop new products.

☉ www.novafastener.com.tw
☉ nova.fasten@msa.hinet.net
鑫星有限公司



_AD.[178]
ON-SPRING INDUSTRIAL

☉ Building Parts, Plastic Washers, Stainless Steel Washers, Bonded Washers, Cup Washers, Pipe Flashings, Rubber Parts, Plastic Parts, Tools, Kits, Stamping Parts, Assembly Parts, Machining Parts, Special Components, Building Components, OEM Parts ☉ On-Spring's main products are mostly building / construction fasteners and materials : such as : * Spring - Seal (TM) pipe flashings & Zip - Seal (TM) retrofit pipe flashings. * Roofing washers, metal, rubber (EPDM or Neoprene, Silicone,...)

☉ www.onspring.com.tw
☉ on.spring@msa.hinet.net
彩羽企業有限公司



_AD.[044]
PENGTEH INDUSTRIAL

☉ Blind Rivets, Shoulder Rivets, Solid Rivets, Split Rivets, Taptite Screws, Plastite Screws, Machine Screws, Rivets, PT Screws, Customized Special Screws / Bolts ☉ We have 26 years of experience in manufacturing screws, rivets and special parts, with factories in Taiwan and China. Size Range: #2- 5/8", (1.5mm-16mm)Material Available: Carbon Steel, Stainless Steel, Brass, Aluminium. Manufacturing screws, rivets and special parts, with factories in Taiwan and China.

☉ www.fastener-world.com/en/supplier/pengteh
☉ pengteh@ms25.hinet.net
彭特企業有限公司



_AD.[185]
POL SHIN ENT. CO., LTD.

☉ Self Drilling Screws, Tapping Screws, Drywall Screws, Chipboard Screws And Automobile Screws ☉ Pol Shin is a professional manufacturer and trader of construction hardwares, high-grade automobile fine fasteners. We owns various advanced manufacturing equipments and a strong team of technicians that responds for designing, development, production, management and quality control. Our products' specification ranges from M2.2 to M10 in diameters, and 5 ~ 400mm in length.

☉ www.polshin.com
☉ polshin.screw@hibox.biz
寶薰股份有限公司



_AD.[237]
PPG INDUSTRIES INTERNATIONAL

☉ Chromium-free Coating, ED Coating ☉ PPG industries is a leader in coating products and coating services markets. PPG developed the cathodic epoxy electrocoat technology and introduced it first to the automotive industry in 1976 as a primer. Alltech Engineered Finishes is the exclusive applicator in Asia Pacific using PPG's latest generation of Electropolyseal coating finishes. PPG has been providing electrocoat products that offer complete, high quality substrate protection to many markets.

☉ www.ppgcoat.com
☉ julialin@ppg.com
美商必丕志國際股份有限公司台灣分公司





PRO POWER CO., LTD.

Deck Screws, Chipboard Screws, Self-drilling Screws, Self-Tapping Screws, Drywall Screws, Furniture Screws, Machine Screws, Sleeve Nuts
 "Always Get Ready for Future Challenges & Impose No Restrictions on Itself" Since its establishment, the specialized supplier of a variety of standard fasteners, Pro Power Co., Ltd., which is also considered "the dark horse" in the industry, has continuously demonstrated its amazing growth potential and marvelous overseas sales increase to the industry.

www.propowerfastener.com
 info@propowerfastener.com
 鉋川有限公司



PRO-PATH INDUSTRIAL

Roofing Screws, Self-drilling Screws, Self-Tapping Screws, Security Screws, SEMS Screws, TEK Screws, Hexagon Washer Head Screws / Bolts, Drywall Screws, Chipboard Screws, Automotive Screws, PVC Screws, Window Screw Drill Point & Sharp Point
 Over 25 years of experience in the fastener field. From raw material to the final products, we control every step of quality and involve every production process to make sure the qualities are stable and offer the best service to our customers.

www.propathindustrial.com.tw
 arky-t-l-kuo@propathindustrial.com.tw
 上展國際實業有限公司



PRO-VISA (LIN) IN'L

Self-drilling Screws, Stainless Steel Screws, Furniture Screws, Deck Screws, Chipboard Screws, Special Screws, Wood Screws, Stainless Steel Self Tapping Screws, Drywall Screws, Machine Screws, Concrete Screws, Particle Board Screws
 PRO-VISA (LIN), based in Taiwan and established in 1996, is specialized in production and trade of fasteners. Certified to ISO 9001 and ISO 14001, PRO-VISA (LIN) is always dedicated to offering customers the best quality control.

www.provisa-fastener.com.tw
 provisa@provisa.com.tw
 俏鼎企業股份有限公司



PS FASTENERS

Washers, Socket Set Screws, U Bolts, Flanged Head Bolts, Machine Screws, Hex Nuts With Conical Washers, Self-locking Pins, Dowel Pins, Blind Rivets, Anchors, Alloy Steel Screws, Flat Head & Socket Head Cap Screws
 PS Fasteners is today in every machine, building and infrastructure. Established since 1982, PS Fasteners is a leading trader of high-quality fasteners serving the diverse industrial needs ranging from infrastructure development to civil engineering and the automotive industries.

www.psfasteners.com
 enquiry@psfasteners.com
 汎昇螺絲有限公司



Q-NUTS INDUSTRIAL

Flange Nuts, Heavy Nuts, Hexagon Nuts, Sleeve Nuts, Tee or T Nuts, Weld Nuts, Wheel Nuts, Spacers, Prevailing Torque Nuts
 We have more than 20 years of experience and it's the first time we try to trade directly with foreign customers, because in the past we did business via trade company, so you can see how competitive our prices would be. In addition to the prices we also have the fastest delivery time and excellent quality. Although we are still small, we are flexible.

q-nuts.webnode.tw
 qnut-vicky@umail.hinet.net
 友俊工業股份有限公司



QST INTERNATIONAL

Hexagon Head Bolts, Square Head Bolts, Weld Bolts (studs), Combined Screws, Flange Screws, Taptite Screws, Plastite Screws, Mathread Screws, Double-head Screws / Bolts, Automotive Parts
 Through continuous adaptation, innovation and crossing the boundaries, QST has grown into a \$350 million fastener company and evolved into a diversified full service provider with operational sites located in Asia, Europe and America.

www.qst.com.tw
 qstmail@qst.com.tw
 恒耀國際股份有限公司



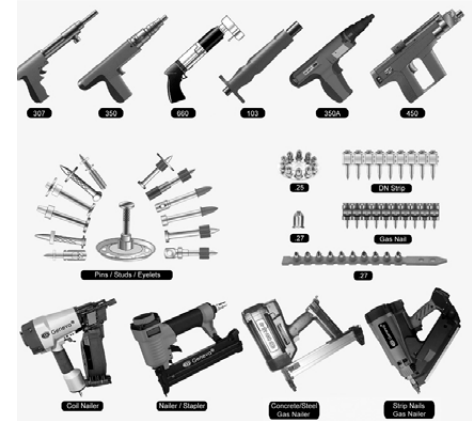

QUAN LIAN ENTERPRISE

☎ Weld Screw, Welding Screw Automatic Machine, Welding Screw Semi-Automatic Machine, CNC Machining Automatic Machine, CNC Machining Semi-Automatic Machine, High-Frequency Annealing Heat Treatment Machine ☎ Quan Lian is a professional Welding Screw Machinery Manufacturer. We are willing to transfer screw manufacture technology to those who purchase our machines. We have several years of experience in screw production and machinery and then there is always positive feedback from our customers.

☎ www.w.fastener-world.com/en/supplier/quantian
 ☎ quantianbusiness@gmail.com
 全鍵有限公司



RAY FU ENTERPRISE

☎ Chipboard Screws, Drywall Screws, Furniture Screws, Wood Screws, Thread Cutting Screws, Roofing Screws, Self-drilling Screws, Machine Screws, Twinfast Woodscrews, Deck Screws, Triangular Thread Screws, Hexagon Head Cap Screws, Construction Products, Drywall Fixing System ☎ RAY FU, founded in 2000, is a professional and successful exporter of all kinds of fasteners and steel wires in Taiwan. We are certified to ISO 9001, ISO 14001, IATF 16949, ETA, TAF, CE EN14592, and EN 14566 to meet any demands from customers.

☎ www.ray-fu.com
 ☎ export@ray-fu.com
 瑞滙企業股份有限公司



REDWOOD INDUSTRIAL

☎ Cutting Tools In General, Drive Pin & Washer Assembly Machines, Special Parts, Staple Guns, Fuel Cells, Air Tools, Gas Actuated Tools (including Gas Fuel Cells), Power Actuated Tools (including Power Loads), Associated Pins, Nails, Staples, Fixings, etc. ☎ Redwood one-stop fasteners shopping center, saving your time, energy, money... Our company was established in 1980 with a license for fasteners factory in Taiwan and China, we have experienced sale people, good quality products, prompt delivery, and excellent service.

☎ www.redwoodnilli.com
 ☎ redwood@redwoodnilli.com
 鴻牧實業有限公司

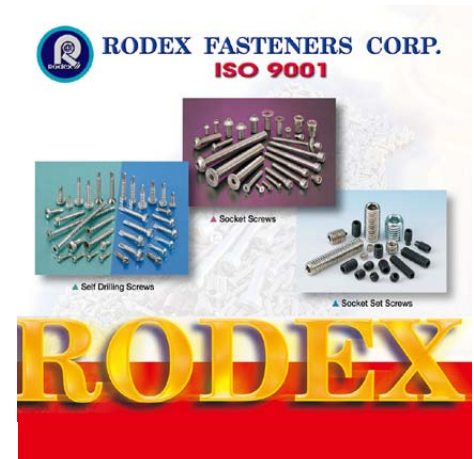
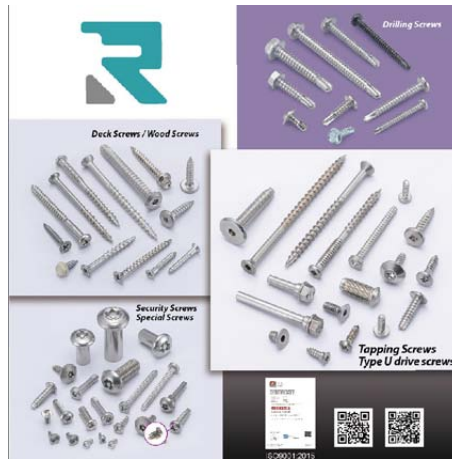

REXLEN CORP.

☎ Rivets, PPAP Documents, Clinch Nuts, Clinch Studs, Customized Special Screws/Bolts, Machine Screws, CNC Parts, CNC Lathes, Forged and Stamped Parts, Injection Molding Machine Screws, A193 B7 Screws, All Kinds of Screws, Custom Bolts ☎ We would like to introduce ourselves as a Multi-Forming Cold Forged/CNC Fastener manufacturer for more than 35 years, with facilities both in Taiwan and China. We offer a wide range of fastener products, both custom-made and standards.

☎ www.rexlen.com.tw
 ☎ rexlen@rexlen.com.tw
 連宜股份有限公司



REXSON FASTENERS

☎ Deck Screws, Wood Screws, Self-drilling Screws, Tapping Screws, Drive Screws, Security Screws, Special Screws, Stainless Steel Screws, Automotive Parts, Special Products Development, Special Functional Parts, Customers' Prints, Drilling Screws, Type U Threads, Security Screws, Machine Screws, Tri-lobular Screws, SEMS Screws, Automotive Parts, Special Designed Parts

☎ www.rexson.com.tw
 ☎ sales@rexson.com.tw
 睿聯工業有限公司



RODEX FASTENERS

☎ Chipboard Screws, Hexagon Head Cap Screws, Socket Head Set Screws, Triangular Thread Screws, High Low Thread Screws, Self-drilling Screws, Machine Screws, Button Head Socket Cap Screws, Socket Set Screws, Blind Rivets, Flat Head & Socket Head Cap Screws, Self-Tapping Screws ☎ Rodex, a manufacturer and exporter, is the largest professional stainless steel wire and screw producer with top quality and complete inspection equipment.

☎ www.rodex.com.tw
 ☎ alicia.yu888@gmail.com
 華祺工業股份有限公司





_AD.[303]
RONG CHANG METAL

☉ Cup Washers, Custom Washers, Flat Washers, Lock Washers, Sems Washers, Split Washers, Spring Washers, Square Washers, Toothed Washers, Carbon Steel Washers, External Tooth Washers, High Strength Washers ☉ Rong Chang has more than thirty years of experience in hardware in Taiwan. We are specialized in producing all kinds of Washer and Special Stamping Parts according to customers' drawing or samples with various materials.

☉ www.rongchang.com.tw
☉ peter@rongchang.com.tw
榮創企業股份有限公司



S&T FASTENING INDUSTRIAL

☉ Masonry Nails, Bi-metal Self-drilling Screws, Wood Screws, Steel Nails, (Steel) Wire Nails, Bi-metal Screws, TEK Screws, Roofing Screws, Self-drilling Screws ☉ "S&T Fastening", operating for over 15 years in Kaohsiung Taiwan, is one of the leading suppliers in manufacturing fasteners, fixings and screws products. S&T Group owns the factories in Kaohsiung (Taiwan), Bangkok (Thailand) and Tianjin (China). S&T Group factories can offer high capacity for the market all over the world.

☉ www.sntfastening.com.tw
☉ info@sntfastening.com.tw
順通國際股份有限公司



_AD.[006]
SAN SHING FASTECH

☉ Custom Washers, Automotive Nuts, Weld Nuts, U Bolts, Weld Bolts (studs), Wheel Bolts, Carbide Dies, Conical Washer Nuts, Optical Sorting Machines, Geomet® & Dacromet®, Automotive Parts, Carbide Pins ☉ The company was established in 1965 and is now the largest professional manufacturer of steel nuts worldwide. In 1968, "San Shing Fastech Corp." was ahead of other companies in the same industry in completing the development of the "High speed nut forming machine", which enables the consequent production of nuts.

☉ www.sanshing.com.tw
☉ sanshing@mail.sanshing.com.tw
三星科技股份有限公司



_AD.[371]
SANHWNG ENTERPRISE

☉ Pipe Anchors, Spring Washers, Square Head Bolts, Countersunk Screws, Double-head Screws / Bolts, Flange Nuts, Wall Anchors, Countersunk Bolts, Button Head Socket Cap Screws, Double Thread Screws, All Kinds of Nuts ☉ We specialize in bolts, nuts, anchor, screws (concrete, spacer, stainless steel screws...etc.) and customized CNC parts! Fine quality & best products and services are our faith!

☉ www.fastener-world.com/en/supplier/sanhwn
☉ sanhwn.edwin@msa.hinet.net
杉冕企業股份有限公司



_AD.[178]
SANSOAR ENGINEERING SALES

☉ Machine Parts, Stamped Parts, Precision Stamped Accessories, Plastic Washers, Precision Plastic Parts, Special Pins, Special Washers, Special Screws, Customized Special Screws / Bolts, Special Parts, Fastener Kits, Assembly Parts, Rubber Parts, Pipe Flashings, Tools, Special Components, OEM Parts, Cold-forming Parts, Pins ☉ Sansoar was founded in 1990 in Kaohsiung, Taiwan. We are ISO 9001 certified and we pay very high attention to Quality Control.

☉ www.sansoar.com.tw/EN
☉ sansoar@hibox.hinet.net
上碩國際企業有限公司



_AD.[279]
SCREW KING CO., LTD.

☉ Bi-metal Screws, Special Screws, Self-drilling Screws, Tapping Screws, Drill Point Dies ☉ Founded in 1995, Screw King., Ltd. is a veteran company specializing in designing, developing and manufacturing high-grade, innovative self-drilling screws. The maker has transformed into a very capable developer and maker of quality self-drilling screw products in recent years after accumulating strong R&D and manufacturing strengths.

☉ www.screwking.com.tw
☉ jinjing.a2@msa.hinet.net
進旌工業股份有限公司





_AD.[160]

SCREWTECH INDUSTRY

● Thread Rolling Screws, Automotive & Motorcycle Special Screws / Bolts, Customized Special Screws / Bolts, Precision Electronic Screws, Alloy Steel Screws, SEMS Screws, Flat Head & Socket Head Cap Screws, Multi-stage Screw & Parts, Shoulder Screws, TEK Screws, Triangular Thread Screws, Open Die Screws
 ● From its beginning in 1998, ScrewTech has become one of the world's leading manufacturers of precision screws and parts for both the domestic and international high tech industry.

● www.screwtech.com.tw
 ● sales@screwtech.com.tw
 銳禾工業有限公司



_AD.[449]

SEN CHANG INDUSTRIAL

● Stainless Steel Wire & Rod, Rivets, Customized Special Screws / Bolts, Flat Head & Socket Head Cap Screws, High Strength Stainless Steel Screws, Weld Screws, Triangular Thread Screws, TEK Screws, Tamper-proof Screws, Socket Head Cap Screws, High Temperature Screws, PT Screws
 ● Sen Chang Industrial Co., Ltd. established in 1968, is now famous as an international specialist for manufacturing stainless steel screws and wires. As per customer's drawing and samples or IFI, DIN BS, JIS standard.

● www.senchang.com
 ● sc337@ms6.hinet.net
 昇鋁實業股份有限公司



SHANG PENG CO., LTD.

● Thread Forming Screws, Self-drilling Screws, Roofing Screws, SEMS Screws, Self-Tapping Screws, Machine Screws, Concrete Screws, Collated Screws, Drywall Screws, Wood Screws, Lag Screws, Chipboard Screws
 ● Shang Peng was founded in 2005. Shang Peng is not an ordinary trading company but a company with full support by one of the top three screw manufacturers in Taiwan. The plant is 6789 square meters with 80 operators in the forming production line.

● www.fastener-world.com/en/supplier/spc
 ● goshangpeng@gmail.com
 上朋有限公司



_AD.[440]

SHANGHAI FAST-FIX RIVET

● Blind Rivets, Open Type Rivets, Closed-End Type Rivets, Multigrip Rivets, Peel Type Rivet, Tri-Fold Rivet, Grooved Rivets, High Strength Rivets, Structural Rivets, Countersunk Rivets, Blind Nuts, Special Rivets, High Shear Rivets, Bifurcated or Split Rivets, Hand Rivet Tools
 ● Over 20 years experience in production & export of blind rivets, Shanghai Fast-Fix Rivet Corp. is the leading manufacturer of blind rivets in China. Fast-Fix is IATF 16949 and ISO 9001 certified.

● www.fastfix-rivet.com
 ● info@rivet-china.com
 上海飛可斯鉚釘有限公司



SHANGHAI RIVET MANUFACTURE

● Stainless Steel Rivet Nuts, Carbon Steel Rivet Nuts, Copper & Aluminum Rivet Nuts, Weld Nuts, Blind Nuts, Clinch Nuts, Insert Nuts, Hexagon Nuts, Tee or T Nuts, Flange Nuts, Nylon Locknuts
 ● Established in 1994, Shanghai Rivet Manufacture Co., Ltd. is located in Shanghai Jinshan Industrial park China. Our company covers an area of 30,000 square meters and has more than 200 employees. We have top-ranking production technology, advanced equipment and great design ability.

● www.ret-global.com
 ● sales@ret-global.com
 上海銳拓五金製品有限公司



_AD.[192]

SHEH FUNG SCREWS

● Wood Screws, Self-drilling Screws, Collated Screws, Concrete Screws, Drywall Screws, High Low Thread Screws, Roofing Screws, Self-Tapping Screws, Twinfast Woodscrews, Stainless Steel Screws, Composite Screws, Deck Screws
 ● Sheh Fung was founded in 1973. Sheh Fung has developed and manufactured a wide range of screws for different functions over the past 47 years. Sheh Fung provides not only high quality products but also the best ODM service to meet customers' demands.

● www.shehfung.com
 ● shehfung@shehfung.com
 世豐螺絲股份有限公司





_AD.[190]
SHEH KAI PRECISION

● Bi-metal Self-drilling Screws, Bi-metal Screws, Bi-metal Concrete Screw Anchors, Screw Anchors, Self-drilling Screws, Stainless Steel Wire & Rod, Construction Fasteners, Self-Tapping Screws, Wing Screws, Roofing Screws, Concrete Screws, Multi-stage Screw & Parts ● SHEH KAI was established in 1992 with a total capital of 10 million NT dollars initially and grew continuously to this date with a total capital of 420 million NT dollars. SHEH KAI is a exporter of the 300 series Austenitic Stainless Steel Bi-Metal Self Drilling Screws in Taiwan.

● www.shehkai.com.tw
● info@shehkai.com.tw
世錫精密股份有限公司



_AD.[155]
SHEN CHOU FASTENERS INDUSTRIAL

● Button Head Cap Screws, Chipboard Screws, Concrete Screws, Flange Washer Head Screws, High Strength Stainless Steel Screws, Stainless Steel Bolts, Security Bolts, T-head or T-slot Bolts, Stainless Steel Self Drilling Screws, Stainless Steel Triangular Thread Screws, Stainless Steel Screws, Stainless Steel Metric Screws ● Shen-Chou, the professional stainless steel screws manufacturer was founded in 1989. We are located in Kaohsiung, Taiwan. In our 25 years of history, we have taken "effective service and high quality" as our core spirit.

● www.shenchou.com.tw
● service@shenchou.com.tw
神州螺絲工業有限公司



SHI ZHAN SCREW

● Self-Tapping Screws, Self-drilling Screws, Bi-metal Screws, Machine Screws, Wall Plugs, Customized Special Screws / Bolts, Hand Tools, Collated Screws, Washers, Nuts, Wall Plugs, Autofeed Screwdrivers ● Founded in 2009, SHI ZHAN is a professional supplier to manufacturing, packaging, QC and export. Surface treatment: zinc plated / Ruspert / Dacrotizing / hot dip galvanizing / mechanical galvanizing / black phosphated / copper plated / nickel plated / positive electrode / powder coating.

● www.shizhanscrew.com.tw
● shizhanscrew@gmail.com
世展螺絲有限公司



_AD.[201]
SHIAN FU ENTERPRISE

● Rubber Washers, Nylon Rings, Rubber-to-metal Anti-vibration Sealing Washers, Sealing Washers, Self-sealing Washers, Oil Seals, Oil Rings, Synthetic Rubber Washers ● (SES) Shian Fu Enterprise is a professional sealing solution company, specializing in Bonded Seals, V-Seals, Valve Seals, Gamma Rings, U-Ring, O-Ring, X-Ring, Wiper Seals, Gasket, Valve Stem Seals, Bushing & Bearing Cover, Gasket, Boots, Oil Seals and other sealing products for both OEM's and aftermarket alike.

● www.ses-seal.com
● harry@ses-seal.com
尚福企業股份有限公司

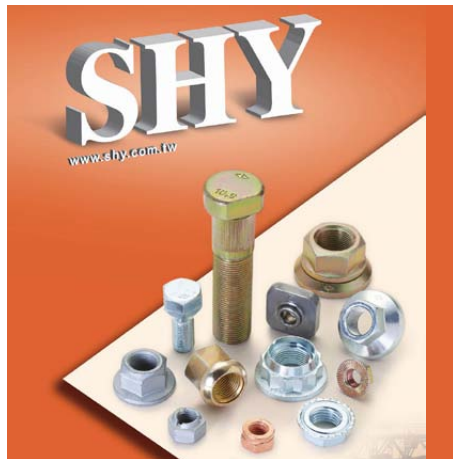

_AD.[032]
SHIH HSANG YWA INDUSTRIAL

● Flange Nuts, Weld Nuts, Wheel Nuts, Wheel Bolts, Flange Screws, Knurled Head Screws, Flange Nylon Nuts With Washers, Prevailing Torque Nuts, Hexagon Washer Head Screws / Bolts, Special Nuts, Flange Nuts, Slot Nuts, Structural Bolts, Nyloc Bolts, Wheel Bolts, Tap Bolts, Cap Screws ● Commitment to quality Nedschroef & Hatebur Hot Formers, Cold Nut Formers, Cold Bolt Formers, In-House Heat Treatment.

● www.shy.com.tw
● shyindco@shy.com.tw
新倡發工業股份有限公司



SHI-HO SCREW INDUSTRIAL

● Micro Screws, Torx Drive System Screws, Taptite Screws, Plastite Screws, Miniature Precision Screws, Shoulder Screws, Stainless Steel Screws, Tapping Screws, Self-locking Screws, Recessed Head Screws, Machine Screw ● Taiwan Nitto Seiko Co., Ltd., establishe in 1969, is a joint venture between Ho Tai Development Co., Ltd., Taiwan and Nitto Seiko Co., Ltd., Japan which respectively owns 50% shares of the company. Main Equipment: Heading Machine 150 sets, Thread Rolling Machine 132 sets, Automatic Optical Sorter 25 sets, Heat Treating Furnaces 3 sets, Plating Equipment 4 sets.

● www.shihoscrew.com
● shiho@shiho.com.tw
旭和螺絲工業股份有限公司



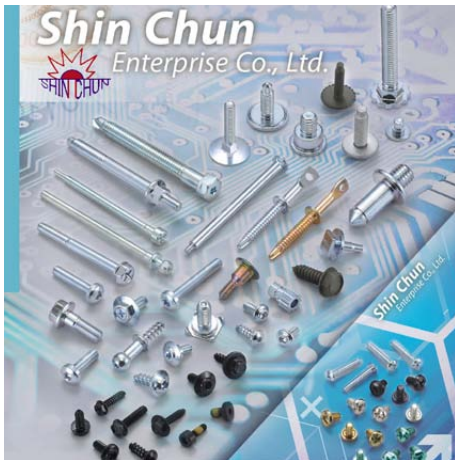

_AD.[168]

SHIN CHUN ENTERPRISE

☉ Thread Forming Screws, Machine Screws, PT Screws, Automotive Screws, SEMS Screws, Socket Head Cap Screws, Self-Tapping Screws, Open Die Screw, Customized Special Screws / Bolts, Plastic Screws, Weld Screws, Triangular Thread Screws, Drywall Screws, Chipboard Screws, Self-Drilling Screws, Concrete Screws, Automotive Screws

☉ For making sure the quality of products is good, we install sorting machines in our factory including roller- and optical-sorters to sort out scraps and unqualified products.

☉ www.sce.com.tw
☉ paul@sce.com.tw
昕群企業股份有限公司



_AD.[247]

SHIN JAAN WORKS

☉ Flanged Head Bolts, Long Carriage Bolts, Round Head Bolts, Shoulder Bolts, Wheel Bolts, Hexagon Head Cap Screws, Flange Washer Head Screws, Self-drilling Screws, Hexagon Washer Head Screws / Bolts, PT Screws, Square Head Cap Screws, Automotive Screws

☉ Shin Jaan, a factory founded in 1974 in Taiwan. The company professionally designs, manufactures, and retails several products including IFI standard (Inch & Metric Sizes), DIN series.

☉ www.shinjaan.com.tw
☉ shinjaan@ms29.hinet.net
新展工廠股份有限公司

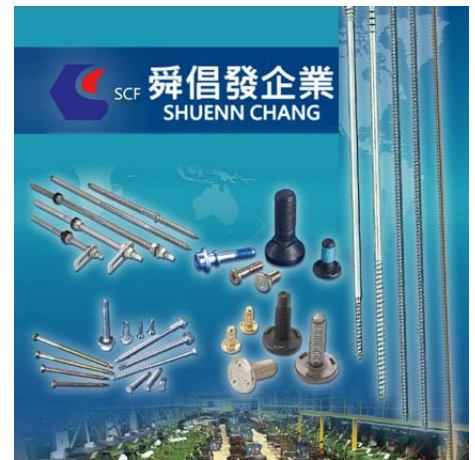

_AD.[158]

SHUENN CHANG FA ENTERPRISE

☉ Chipboard Screws, Flange Screws, Weld Screws, Wood Screws, Triangular Thread Screws, High Low Thread Screws, Self-drilling Screws, Machine Screws, Flange Washer Head Screws, Concrete Screws, Unrestricted-length Screws / Bolts, TEK Screws

☉ "Trustable, Innovative, Profitable and Growth" is our business concept. Shuenn Chang Fa was established in 1984. The main products are screws in all types of materials.

☉ www.scffastener.com
☉ scf.mail@msa.hinet.net
舜昌發企業股份有限公司



_AD.[139]

SHUN DEN IRON WORKS

☉ Fastener Tools, Bolts, Screws, Nuts, Link Chains, Steel Wire Rope Products, Turning & Cutting Parts, Stamping Parts, Hardware, Rigging, Casting & Forging Parts, Wrought (Forged) Products

☉ Shun Den Iron is a specialized manufacturer of wire products, forged and die-casting parts, and fasteners, mainly for cargo ships, construction, machinery, and industrial purposes. It supplies screws, nuts, and other industrial parts in customized sizes and specifications.

☉ www.shun-den.com.tw
☉ shunden@seed.net.tw

順典鐵工廠股份有限公司



_AD.[152]

SIN HONG HARDWARE

☉ Hexagon Nuts, Hexagon Head Bolts, Blind Rivets, A193 B7 Screws, All Kinds of Screws, U Bolts, U Nuts, Cage Nuts, Anchor Bolts, Washers, Cotter Pins, Clinch Studs

☉ Sin Hong has expanded rapidly to become one of the larger stockists and distributors of a wide range of industrial fasteners, and a specialist in Standard, Non-standard and customised Fasteners. Sin Hong is committed to work toward full comprehensive range in stock items and be recognised as a preferred supplier in the region.

☉ www.sinhong.com
☉ exportsales@sinhong.com.sg



_AD.[291]

SOON PORT INTERNATIONAL

☉ Carbon Steel Screws, Chipboard Screws, Color-coated Screws, Composite Screws, Machine Screws, Metal Screws, Self-drilling Screws, Self-Tapping Screws, Triangular Thread Screws, Twinfast Woodscrews, Wood Screws, Washer Head Screws

☉ Soon Port was founded in 1962 as a manufacturer in producing hardware wires, screw wires, steel wires and OEM. In the 1990's, Soon Port set up the production lines of hardware, nails and screws.

☉ www.soonport.com
☉ info@soonport.com

鴻錫興業股份有限公司



WEDGE LOCKING WASHER

Capability M3-M52 Alloy Steel : Apply Up to Grade 12.9
M3-M52 S/S 316L : Apply Up to A4-80



Special Fasteners Engineering Co., Ltd.
S.F.E • Service • Flexibility • Expertise



An international manufacturer of automotive fasteners
SFE specializes in supplying 100% sorted high quality screws & bolts for the automatic assembly application.



Six Billion (6,000,000,000) pieces
Blind Rivets Annually

_AD.[027]
SPEC PRODUCTS CORP.

Automotive Nuts, Ball Ended Screws, Flare Nuts, Taptite Screws, Mathread Screws, Matpoint Screws, Bushings, Torx Drive System Screws, Lock Washers, Multi-strokes Special Screws / Bolts, Prevailing Torque Nuts, Locking Screws
SPEC Products Corp. provides full services for all fasteners made as per customers' prints & specifications supported by well trained & expertised sales & manufacturing engineers.

www.spec.com.tw
jessie@spec.com.tw
友誠股份有限公司



_AD.[174]
SPECIAL FASTENERS ENGINEERING (SFE)

Flange Screws, Hexagon Head Cap Screws, Flange Washer Head Screws, Triangular Thread Screws, High Low Thread Screws, Mathread Screws, Machine Screws, Hexagon Washer Head Screws / Bolts, PT Screws, Clinch Studs, Tapping Screws, Machine Screws, Multi-Station Formed Bolts, Special Screws
SFE, located in Taiwan, manufactures an extensive line of screws. We produce over 2.4 billion components a year with a wide range of fasteners from 2.5mm up to 10mm diameter, and specifically to customer drawings.

www.sfe.com.tw
sfe.tw@msa.hinet.net
托福實業股份有限公司



_AD.[014]
SPECIAL RIVETS CORP. (SRC)

Blind Rivets, Flat Head Rivets, Hand Riveters, Blind Nuts / Rivet Nuts, Closed End Rivets, Hand Rivet Tools, Hand Rivet Nut / Rivet Bolt Tools, Air Hydraulic Rivets, Multigrip Rivets, Painted Rivets, Countersunk Rivets, High Strength Rivets, Rivet Nut Tools, Structural Rivets
SRC, established in 1983, specializes in manufacturing blind rivets, blind rivet nuts and riveting tools. With two ISO 9001 certified facilities in China, we manufacture 6000 million blind rivets and 200,000pcs high-quality riveters annually.

www.scrivet.com
srcrivet@ms12.hinet.net
恆昭企業股份有限公司



_AD.[156]
STARBEST ENTERPRISE

Chipboard Screws, Drywall Screws, Roofing Screws, Self-drilling Screws, Taptite Screws, Plastite Screws, Machine Screws, Hexagon Washer Head Screws / Bolts, Automotive Parts, Special Parts, Stamped Parts, Tapping Screws, Hex Cap Screws, Socket Cap / Set Screws, Carriage Bolt, Hex Nuts, Flange Nut, Washers, Drop In / Wedge / Sleeve Anchor, Concrete Screws, Wedge Bolts
Established in 1976, Starbest exports Industrial Fasteners and Expansion Anchors, including OEM parts, specially designed parts.

www.starbest.com.tw
sales@starbest.com.tw
展洋企業有限公司



COMEFIRMAT.SCREW KD.FITTINGS EURO.SCREW
JOINT.CONNECTOR.BOLT JOINT.CONNECTOR.NUT
CHIPBOARD.TAPPING DRYWALL.PARTICLE.BOARD
MACHINE.SCREW HANGER.BOLT STUD.THREAD.ROD
SHELF.SUPPORT INSERT.NUT BARREL.NUT TEE.NUT
SPECIAL.CUSTOM.PRODUCT

_AD.[271]
STEEL STONE CO., LTD.

Drywall Screws, Furniture Screws, Hexagon Head Cap Screws, Sheet Metal Screws, Washer Head Screws, Double Lead Thread Screws, High Low Thread Screws, Machine Screws, Double-head Screws / Bolts
We were established in 1999 and we are a supplier of all kinds of furniture screws in Taiwan. Members of the management team are a group of well-experienced people from the industry who have the ability to invent and produce products with the know-how and techniques.

www.steelstone.com.tw
ststone@ms61.hinet.net
岡岩有限公司



SUN CHEN
Satisfy All Your Needs!!
Various Fasteners
Available for Special Design
PPAP Available

_AD.[050]
SUN CHEN FASTENERS

(Steel) Wire Nails, Barrel Nuts, Machine Screws, Clinch Stud Screws, All Kinds of Nuts, Customized Special Screws / Bolts, CNC parts, CNC Lathes, Stamped Parts, Hardware, Hex Keys, Carbon Steel, Stainless Steel
We are a trading company. Our supply lines are wide and the parts could be per customers' requests or standard spec. There are over 100 partners behind us. Thus we can always offer good price with high quality & on time delivery to our customers.

www.fastener-world.com/en/
supplier/sun-chen
sunchan@ms9.hinet.net
展鴻鑫股份有限公司





_AD.[090]
SUPER CHENG INDUSTRIAL

☉ Automotive Nuts, Flange Nuts, Hexagon Nuts, Kep Nuts, Flange Nylon Nuts With Washers, Prevailing Torque Nuts, Socket Head Bolts, Flanged Head Bolts, American Standard Nuts, Cold Forged Nuts, Metric Nuts, Lock Nuts ☉ Super Cheng was founded in 1981 in Kaohsiung, Taiwan. Super Cheng has been carefully manufacturing to meet the world-wide industrial and technical needs of the industry, and it's industrial & construction "Nuts" are manufactured to rigid quality control procedures.

☉ www.superchengco.com
☉ sales@superchengco.com
世暘工廠產業股份有限公司



_AD.[121]
SUPER DPD CO., LTD.

☉ All Kinds of Screws, Bi-metal Screw, Carbon Steel Screws, Construction Fasteners, Chipboard Screws, Self-drilling Screws, Self-Tapping Screws, Wing Screws, TEK Screws, Collated Screws, Concrete Screws, Corrosion Resistant Screws ☉ A Total solution of Self-drilling screws, SUPER DPD is a Taiwan based company founded in 1995 by Mr. Bill Cheng, specialized in R & D and production of Drill Point Die & screws. In 2000 we succeeded in developing Center-Point design which proves highest drill performance.

☉ www.drawlin.com.tw
☉ service@drawlin.com.tw
三御股份有限公司



_AD.[242]
SUPER NUT INDUSTRIAL

☉ Blind Nuts / Rivet Nuts, Clinch Nuts, Tubular Nuts, Blind Rivet Studs, Rivets, Brass Inserts, Turning Parts, CNC parts, CNC Lathes, Bolt Rivet Nuts, Clinching Parts, Sex Bolts & Binding Post Screws, Special Cold Forging Parts ☉ SUPER NUT was founded in 1975. From the old era of 1-die 2-blow cold headers for rivets, leather hardware and binding posts, to modern multi-stage cold forging for fasteners. Our product applications include: furniture, transportation (air, land, and sea), agriculture, construction, and electronics...

☉ www.super-nut.com.tw
☉ service@super-nut.com.tw
傑螺工業股份有限公司



SUPERIOR QUALITY FASTENER

☉ Heavy Nuts, Flange Screws, Hexagon Head Cap Screws, Weld Screws, Hexagon Nuts, Automotive Screws, Automotive Nuts, Tubes, T-head or T-slot Bolts, Construction Bolts, U Bolts, Weld Nuts ☉ We were established in 1998 and provide a wild range of components right from standard to customized screws, nuts and fasteners per individual customer requirement. In order to catch the trend and satisfy customers' demand, we have acquired IATF 16949 quality certificate in 2001.

☉ www.sqf.com.tw
☉ sqf@sqf.com.tw
鑫程棧股份有限公司



_AD.[269]
TAIWAN KODAI CO., LTD.

☉ Brass & Bronze Screws, Turning Parts, Metal Injection, Sinter Parts, Aluminum Material, CNC Parts, CNC Lathe, Precision Machining, Investment Casting/Lost Wax, Sand/Gravity Casting, Die Casting, Forging/Cold Heading, Metal Injection Molding (MIM), Sintered/Powder Metal, Fine Blanking, Metal Stamping/Fabrication/Forming for Manufacturing Parts, Components ☉ Taiwan Kodai was established in 1989. At the beginning, we supplied electric tools and accessories of Hitachi K. K. Japan.

☉ www.kodai.com.tw
☉ sales@kodai.com.tw
台灣向大企業有限公司



_AD.[233]
TAIWAN LEE RUBBER

☉ Bonded Washers, Custom Washers, Rubber Washers, Silicone Washers, Galvanized Washers, Structural Washers ☉ TAIWAN LEE RUBBER (TLR) was established since 1986. We are a Taiwanese washer supplier specialized in a full range of 100% EPDM washers such as Bonded Washer, Cut Washer, BAZ Washer, Flash, Dichtungsen Washer, Double Seal Washer, DOME Washer...etc. that could be applied on roofing, automobile, solar, and equipment areas. EPDM is a stable material with saturated chemical structure.

☉ www.bonded.com.tw
☉ taiwanlee@bonded.com.tw
台力橡膠股份有限公司



Main Products

- Nylon Washer • Plastic Nut
- Flat Washer • Rubber O-Ring
- Cap Nut • Various Plastic Products
- Plastic Screw Products

主要產品

- 尼龍墊圈 • 塑膠螺帽
- 平墊圈 • 橡膠O型環
- 蓋帽螺絲 • 各種塑膠螺絲
- 各種塑膠螺絲

_AD.[203]
TAIWAN NYLON WASHER

• Rubber Washers, Silicone Washers, Plasterboard Nails, Plastic Bolts, Plastic Dowel Rods & Pins, Plastic Nuts, Plastic Rivets, Plastic Screws, Plastic Washers

• We are an ISO approved manufacturer specializing in nylon washer/flat washer, and we have been in this field for more than 35 years. In addition to nylon washers for nylon insert lock nut(DIN985/986), flat washer (DIN125), we added nylon spacers, special fasteners and rubber parts (O-rings, washers) in our service range.

• www.taiwannylonwasher.com.tw
• twnylon.washer@msa.hinet.net
東佑典實業股份有限公司



SHANK SLOTTING MASTER

PROFESSIONAL IN WOOD SCREW

Industrie 4.0?
Mill Point Self Drilling Screw is Excellent for Automatic Assembly Line

- Chipboard Screw
- Wood Construction Screw
- Mill Point Self-Drilling Screw
- Terrace Screw / Deck Screw
- Timber Screw
- Self-Drilling Screw
- Self-Tapping Screw

TPF XDC point
TPF X point

XDC point test videos and comparison videos are available, please email us to get video link

CE
ETA
ETA

_AD.[169]
TAIWAN PRECISION FASTENER

• 6 Cuts / 8 Cuts Self Drilling Screws, Chipboard Screws, Deck Screws, High Low Thread Screws, Particle Board Screws, Roofing Screws, Self-drilling Screws, Screws in small packs, Self-Tapping Screws, Twinfast Woodscrews, Wood Screws, Composite Screws

• Taiwan Precision Fastener (TPF) has been serving the fastener industry for many years. At the beginning, we manufacture screws for our local customers and now we go global. TPF owns many patents about screws. TPF R&D policy is to design and develop 1~2 new innovative products each year.

• www.taiwan-precision-fastener.com
• sales@taiwan-precision-fastener.com



TSLG 耐落

價值解決方案提供者
Value Solution Provider
螺絲防鬆首選品牌
全球最大扣件預塗科技研發及服務中心

NYLON® precote®

www.tslg.com.tw

_AD.[082]
TAIWAN SELF-LOCKING FASTENERS IND.

• Screws and Nuts Locking and Sealing Process

• From the smallest point creates largest world records. Since 1984 TSLG introduced pre-coating service on fastener, "become the world's largest and most complete pre-coating functional treatment centre" is our greatest motivation. Thus, we always offer clients complete suggestion on self-locking fasteners. We are willing to assist customers in archiving their great dream and willing to play the role of the best supporter.

• www.tslg.com.tw
• tslg.kh@tslg.com.tw
台灣耐落螺絲工業股份有限公司



_AD.[207]
TANG AN ENTERPRISE

• Flange Nuts, Bushings, Spacers, Weld Nuts, Special Nuts, Tubes, Prevailing Torque Nuts, Washers, Piston Pins, Automotive Parts, Sleeve Nuts, Special Parts, T Nuts

• Customized Automotive Parts and Special Fasteners Manufacturer.

• www.fastener-world.com/en/supplier/tangan
• tang-an@umail.hinet.net
鎧安企業有限公司



TENZ

- 47 patents worldwide
- local and product licensing
- most wanted decking screw technology in the USA
- most awarded wood screw worldwide

TENZ INTERNATIONAL

• TENZ® LOW-ENERGY SCREW (With Red Dot Award) Reduced friction along the thread; Significantly reduces screwing resistance; Longer tool life and increased application equipment service life; Lower screwing effort and power demand increase work safety

• The company TENZ International Ltd. was founded in Taipei under the management of Spencer Wang for the global distribution of the newly invented wood building screw. As experienced Managing Director for well-known companies such as Philip Morris USA or SCA Sweden.

• www.tenz.com.tw
• spencer.wang@tenz.com.tw
登馳國際有限公司



_AD.[013]
THREAD INDUSTRIAL

• Iron or Steel Wire Rods, Flange Nuts, Heavy Nuts, Hexagon Nuts, Self-locking Nuts, Hexagon Head Bolts, Chipboard Screws, Drywall Screws, Structural Bolts, Lag Bolts, Automotive Nuts, Structural Nuts

• Philosophy: Sincerity, Dependability, Innovation. Principles: Continuous operation, pursuit of excellence to encourage the entire fellow workers in accordance with the sincere spirit to manufacture products which meet customers' demand and quality.

• www.ticl.com.tw
• Lawrence@ticl.com.tw
英德工業股份有限公司





_AD.[448]

TICHO INDUSTRIES

☉ Bi-metal Self-drilling Screws, Coil Nail Collator, Nut Tapping Machines, Self-drilling Screw Forming Machines, Tooling for Forming Machines, Thread Rolling Die Plates, Phillips Punches, Multi-station Cold Forming Machines, Thread Rolling Machines, Collated Screws, Bi-metal Screws ☉ K TICHO, founded in 1982, world-renowned professional manufacturer of Plastic Collated Screws, Bi-Metal Screws, Coil Nail Collators and Nail Rolling Machines.

☉ www.screw-nails.com.tw
 ☉ service@ticho.com.tw
 帝潮實業有限公司



TIGGES TAIWAN BRANCH

☉ Cold Forming, Hot Forging, Stamping, Machining, Grinding (Everything from One Source)
 ☉ Founded in 1925 and still a consequently family-owned business, TIGGES is one of today's major specialized manufacturers of fasteners and connection elements worldwide. The use of our four in-house production methods cold forming, machining, grinding and hot forging enables us to produce individual products with highest flexibility.

☉ www.tigges-group.com
 ☉ info@tigges-group.com
 德商殷士諦股份有限公司台灣分公司



_AD.[288]

STONE DAR SEEN ENTERPRISE

☉ Multi-stage Screws & Parts, Dowel Pins, Special Screws, Semi-tubular Rivets, Truss Head Rivets, Special Rivets, Pan Head Rivets, Shoulder Rivets, Multi-stroke Rivets, Button Rivets, Flat Head Rivets, Solid Rivets ☉ TDS is a manufacturer of professional rivets which was founded in 1983 in Taiwan. We produce various types of screws, specializing in rivets, multi-stage screws and custom / special designed parts. We devote ourselves to improving productivity, on-time delivery and high-quality product control.

☉ tonedarseen.com/en/home
 ☉ tdstds.chiao1029@gmail.com
 通達興企業有限公司



_AD.[054]

TONG HEER FASTENERS (THAILAND)

☉ Stud Bolts, Stainless Steel Nuts, Stainless Steel Bolts, Stainless Steel Screws, DIN 933, DIN 931, DIN 912, JIS B1180, JIS B1176, Hex. Head Cap Screws, Hex Tap Bolts, DIN 976, Stud Bolts ☉ Tong Heer was established by the Tong group in 1989 (Malaysia's factory) and 2005 (Thailand's factory) for manufacturing stainless steel fasteners. TONG group is an international stainless steel fastener manufacturing group with several manufacturing bases in Malaysia, Thailand and China. Experience and advantages from the TONG group.

☉ www.the.com.my
 ☉ sales5@tong.co.th



_AD.[055]

TONG HEER FASTENERS (MALAYSIA)

☉ Stainless Steel Metric Screws, Stainless Steel Screws, Stainless Steel Nuts, Stainless Steel Bolts, DIN 603, DIN 912, DIN 931, DIN 933, DIN 7991, JIS B1180, ISO 7380, JIS B1176, Wood Screws, DIN 439, DIN 934, Hex Nuts, JIS B1181, ISO 4032, Stud Bolts & Threaded Rods ☉ Tong Heer was established by the Tong group in 1989 (Malaysia's factory) and 2005 (Thailand's factory) for manufacturing stainless steel fasteners. TONG group is an international stainless steel fastener manufacturing group with several manufacturing bases in Malaysia, Thailand and China.

☉ www.tong.com.my
 ☉ tongheer@tong.com.my



_AD.[302]

TONG HO SHING INTERNATIONAL

☉ Stainless Steel Hex-Washer Sockets, Stainless Steel Hex-Washer Screws, Stainless Steel Machine Screws, Stainless Steel Round Washer Head Screws, Stainless Steel Self Drilling Screws, Carbon Steel Self Drilling Screws, Wood Screws ☉ Originally founded in 2011 in Kaohsiung, the person in charge, Mr. Lin Yilong, has a steady and steady attitude and a customized spirit to produce all kinds of stainless steel and black iron screws.

☉ www.tonghoshing.com.tw
 ☉ mini952952@gmail.com
 桐和興實業有限公司



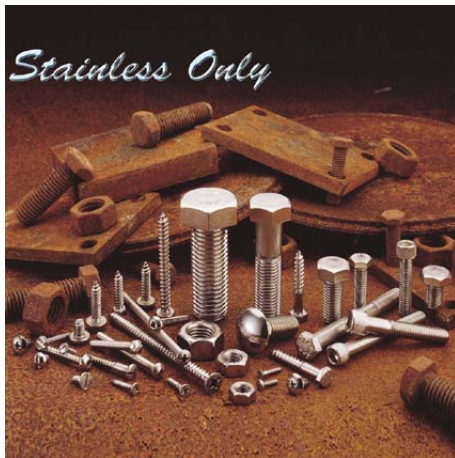

_AD.[016]
TONG HWEI ENTERPRISE

☎ Lag Screws, Stainless Steel, Hexagon Nuts, Flanged Head Bolts, Machine Bolts, Round Head Bolts, Button Head Socket Cap Screws, Hexagon Head Cap Screws, Socket Head Cap Screws, Machine Screws, A2 Cap Screws, Coach Screws
 ☎ Tong Hwei has grown to be the leading Stainless Steel Fasteners manufacturer in the world. We not only specialize in standard products to the international specifications but also are skillful in the engineered products to blue prints.

☎ www.the.com.tw
 ☎ the@the.com.tw
 東徽企業股份有限公司



_AD.[054]
TONG MING ENTERPRISE

☎ Cap Nuts, Flange Nuts, Heavy Nuts, Hexagon Nuts, Hexagon Head Bolts, Hexagon Head Cap Screws, Machine Screws, Hexagon Washer Head Screws / Bolts, 6 Cuts / 8 Cuts Self Drilling Screws, Thread Rods, Steel Bars (Hex/ Round/ Square), Stainless Steel Wire Rods
 ☎ TONG is a multi-national stainless steel fastener manufacturing group with several manufacturing bases in Malaysia, Thailand, China, and Taiwan.

☎ www.tongming.com.cn
 ☎ export@tongming.com.cn
 浙江東明不銹鋼製品股份有限公司



_AD.[222]
TR FASTENINGS LTD.

☎ All Kinds of Nuts, All Kinds of Screws, Washers, Sheet Metal Screws, Inserts For Plastic, Spacers, Precision Plastic Parts, Security Screws, Blind Rivets, Self-locking Nuts
 ☎ TR Fastenings Ltd (TR) is part of Trifast plc and is an international specialist in the design, engineering, manufacture and distribution of high quality industrial and Cat C fastenings principally to major global assembly industries. TR has 33 business locations within the UK, Asia, Europe and the USA including 8 manufacturing sites.

☎ www.trfastenings.com
 ☎ sales@trfastenings.com



_AD.[210]
TRINITY STEEL

☎ Paper Strips, Plastic Strips, Wire Coils, Threaded Rods, Anchor Bolts, Foundation Bolts, U Bolts, Plastic Collation, Wire Collation, Straprite Collation, Bulk Common Nails, Bulk Finish Nails, Bulk Sinker Nails
 ☎ We manufacture and distribute Specialized Steel products such as Engineered Fasteners, Concrete Accessories, Coated Wire and other products that primarily cater to the Industrial and Construction sectors. Our Clients are spread across the globe in countries such as U.S.A, Canada, U.K, Australia, South Korea, India, South America, Africa, UAE, Europe and a few other countries.

☎ www.trinitysteel.lk
 ☎ marketing@trinitysteel.lk

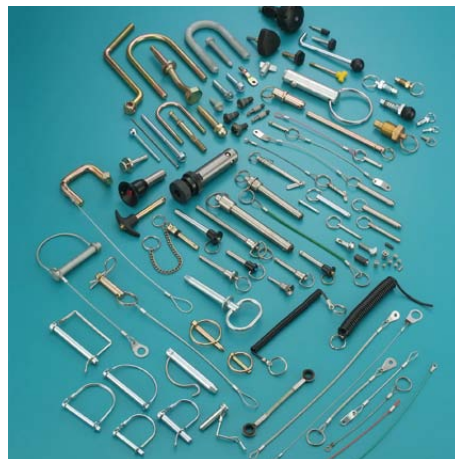

_AD.[136]
TSAE FARN SCREWS HARDWARE

☎ Bar Pins, Chain Pins, Clevis Pins, Core Pins, Detent Pins, Combination Washers, Cotter Bolts, Aircraft Nails, Aluminum Material, Automotive Screws, A2 Cap Screw, All Kinds of Screws
 ☎ We are a well-experienced technical team and like to serve you with any problems about fasteners. Your designs, samples and drawings are welcome. We're devoted to R&D of a great deal of precision products and intergrate processing procedures to control cost and delivery for offering high-quality service.

☎ www.tsaefern.ttnet.net
 ☎ sc.chen@tsaefern.com
 采凡螺絲五金有限公司



_AD.[102]
TSENG WIN

☎ Sleeve Anchors, Wedge Anchors, Spacers, Tubes, Cut Anchors, Drop-in Anchors, Express Nails, Special Cold / Hot Forming Parts, Ceiling Anchors, Special Nuts, Expansion Anchors, Hollow Wall Anchors, Chemical Anchor Studs, Metal Insulation Plugs
 ☎ Oriental Multiple is a professional manufacturer of anchors in the fastener industry since 1993. Establishing plants in Vietnam and Taiwan, Oriental's business has been expanded into USA, Europe, Japan, Australia and other countries worldwide.

☎ www.fastener-world.com/en/supplier/oriental-m
 ☎ tseng558@ms33.hinet.net
 成盈貿易股份有限公司





TSUN CHEN INDUSTRIAL

Professional Assembly Manufacturer. Conical Washer Nuts, Flange Nylon Nuts With Washers, Hex Nuts With Conical Washers, SEMS Screws, Flat Washer Nuts, Nylon Nuts With Conical Washers
 TSUN CHEN INDUSTRIAL CORP. (TC), established in 1990, specializes in research, development, and manufacture of special washer nuts assembly and screw washers assembly. Over 30 years, TC's primary strategies are to satisfy customers' needs, provide the best customized services, and assure the quality of the highest standards.

www.tsun-chen.com
 sales@tsun-chen.com
 總丞工業有限公司



TYCOONS GROUP ENTERPRISE

Weld Bolts (studs), Chipboard Screws, Drywall Screws, Hexagon Head Cap Screws, Roofing Screws, Self-drilling Screws, Self-Tapping Screws, Socket Head Cap Screws, Collated Screws, Deck Screws, TEK Screws, Wood Screws
 Established in 1980, Tycoons Corporation is dedicated to becoming the best partner for its clients worldwide with its management concept – "A desire for new changes and exceeding oneself". It takes advantage of its vertical integration technology, and world-class flexible mass production capability.

www.tycons.net
 twsm2@mail.tycons.com.tw
 聚亨企業股份有限公司



_AD.[132]

UNISTRONG INDUSTRIAL

Retaining Nuts, Sleeve Nuts, Weld Nuts, Wheel Nuts, Flanged Head Bolts, Shoulder Bolts, Wheel Bolts, Knurled Head Screws, Weld Screws, Tee Nuts, Automotive & Motorcycle Special Screws / Bolts, Automotive Fasteners, Stamping Components, Machinery & Tooling plus Whole Plant Export & Planning
 Your One-Stop shopping service provider. Come join us and experience our utmost performance, feel our innovation and expectation with our Quality, Cost, Delivery and Services. We are always here with you.

www.unistrong.com.tw
 sales@unistrong.com.tw
 六曜實業股份有限公司



UNIVERSAL PRECISION SCREWS

Dowel Pins, Shoulder Bolts, Pins (Metric & Inch Series), Piston Pins, Gudgeon Pins, Cylinder Head Bolts, Special Fasteners, Components, Standard Products (Bolts, Screws, Nuts, Allen Keys)
 Universal Precision, is a leading manufacturer of top quality Industrial and commercial fasteners with track records parallel to none in the region. As a customer caring organization, we understand current business climate and ever changing market demand high precision, speed and efficient delivery system. IATF16949, TÜV, ISO-9001, ISO-14001, ISO/IEC-17025, ISO 18001, AS 9100.

www.upsind.com
 customer@upsind.com



_AD.[239]

VAJRA POWER INDUSTRIES

Automotive Parts, Gauges, Torque/Clamping Force Testing System, Long / Short Socket Extension, Bit & Bit Sets, Hand Tools, Hex Keys, Nut Setters, Ratchet Handles
 Vajra Power is a company specialized in manufacturing patented, peculiar and different products to enrich the product value. Because the products that Vajra Power manufactures get improved and are convenient in usage. It is greatly helpful for marketing and marketing profit.

www.vajrapower.com.tw
 info@vajrapower.com.tw
 金和鋼工業股份有限公司

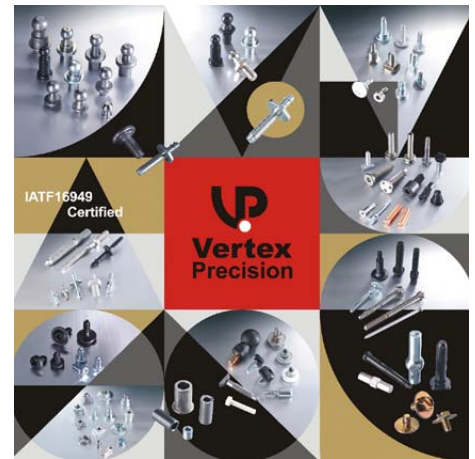

_AD.[098]

VERTEX PRECISION INDUSTRIAL

Automotive & Motorcycle Special Screws / Bolts, Automotive Screws, Ball Ended Screws, Automotive Nuts, Bushing, Tubes, Mathread Screws, OEM/ODM, Matpoint Screws, Multi-stage Screw & Parts, Double-head Screws / Bolts, Customized Special Screws / Bolts
 Vertex Precision is the manufacture of cold forging from Taiwan and supplies Fastener solutions to our customers. We were found in 2005 and have manufacturing plants in Kaohsiung.

www.vertexprecision.com.tw
 sales@vertexprecision.com.tw
 緯絨精密工業股份有限公司





_AD.[126]
WATTSON FASTENER GROUP

☉ Clevis Bolts, 6 Cuts / 8 Cuts Self Drilling Screws, Roofing Screws, Twinfast Woodscrews, Carbon Steel Screws, Chipboard Screws, Drywall Screws, Collated Screws, Farmer Screws, Deck Screws, High Low Thread Screws, Knurled Head Screws
 ☉ Founded in 1982, Wattson, a leading manufacturer and exporter of fasteners, has owned production lines, equipped with 200 sets of automatic machine, 4 sets of heat treatment system, one packaging plant and 2 lab rooms to ensure quality.

☉ www.fastener-world.com/en/supplier/wattson
 ☉ wattsonbell@gmail.com

華盛螺絲股份有限公司



_AD.[222]
WAYNETEL INDUSTRIAL

☉ All Kinds of Screws, Bolts, Nuts, Washers, Special Parts, Packing Series ☉ WAYNETEL was established in July 1987 and grows steadily due to our excellent know-how service and the principle of doing for the best. We always do our very best to offer you the superior quality of products from designing, manufacturing, quality controlling, to delivering. Our high quality bolts and screws even nuts will make the products outstanding, and we are sure that we will be your most reliable partner in this field.

☉ www.waynetel.com.tw
 ☉ sales@waynetel.com.tw

華特企業股份有限公司



_AD.[042]
WE POWER INDUSTRY

☉ Chipboard Screws, Drywall Screws, Sheet Metal Screws, Wood Screws, Roofing Screws, Self-drilling Screws, Tapping Screws, Machine Screws, Thread Forming Screws, Stainless Steel Screws, SEMS Screws, Concrete Screws ☉ We Power is a screw manufacturer in Taiwan with more than 15 years of experience in screw production. With a strong manufacturing background in standard screws, We Power has devoted to the investigation on screw quality and advanced manufacturing / QC techniques.

☉ www.we-power.com.tw
 ☉ service@we-power.com.tw

威力寶貿易股份有限公司



_AD.[229]
WEI IN ENTERPRISE

☉ Clinch Nuts, Cone Nuts, Press Nuts, Spacer, Bushing, Collar, Special Nuts ☉ WEI IN was founded by President Ming Che Kuo in Tainan. When Wei In was established in 1989, its first product was "screw nuts". It and its customers have maintained good relationship for many years, and then it started to improve its forging technique and quality system for the purpose of transferring products costs, and achieving volume production. It has acquired ISO 9001 certificate.

☉ wei_in419@yahoo.com.tw
 ☉ www.weiin-nut.com.tw

瑋瑩實業有限公司



_AD.[368]
WEI ZAI INDUSTRY

☉ Nuts, Including Flange Nuts, Washer, Cap Nuts, Anchor Nuts, T-Type Nuts, Parts of Bicycle & Automobile and Other Special Nuts, Automotive Nuts, Motorcycle Nuts, Wheel Nuts, Nylon Cap Insert Lock Nuts, Flat Washer Nuts, Tubes, Anchors ☉ Wei-Zai Industry was established in 1980, with 30 years of professional manufacture experiences. WEI-ZAI owns professional knowledge and technologies in the field of nut products. We produce various kinds in materials including steel, stainless steel, brass and aluminum alloy.

☉ www.weizai.com.tw
 ☉ weizai.nut@msa.hinet.net

華在螺帽有限公司



_AD.[186]
WELFLY ENTERPRISE

☉ All Kinds of Screws, Automotive Screws, Triangular Thread Screws, Thread Cutting Screws, Flange Screws, High Low Thread Screws, Machine Screws, Automotive & Motorcycle Special Screws / Bolts, Carbon Steel Screws, Clinch Stud Screws, Furniture Screws ☉ Wellfly was established since 1983 and is one of the leading trading companies of "industrial fasteners" in Taiwan. We have a lot of experience in export to U.S.A., Brazil, Canada, U.K., Germany, North-Europe, East-Europe, South Africa, etc.

☉ www.wellfly.com.tw
 ☉ sales@wellfly.com.tw

瑋展企業股份有限公司



EST.1998
screw

MADE IN TAIWAN

William
SPECIALTY INDUSTRY CO.,LTD.

Testing Lab
ISO/IEC 17025:2005

GCL INTERNATIONAL
ISO 14001 5965
Registration No: 19E12881

UKAS
MANUFACTURING SYSTEMS
5965
Certificate No: FS 57284



WP
Professional & Industrial



Flange Bolts → Security Bolts

Your most powerful source for
STAINLESS STEEL SCREW

SEMS Screws →



_AD.[446]
WILLIAM SPECIALTY INDUSTRY

☉ Drywall Screws, High Low Thread Screws, Self-drilling Screws, Taptite Screws, PT Screws, Collated Screws, Concrete Screws, Deck Screws, Chipboard Screws, Self-Tapping Screws, Roofing Screws, Plastite Screws ☉ WILLIAM started by Mr. William Doong in 1998 as fastener packaging business. Soon after, in 1999, a packaging factory was set up which provides professional and high-quality packaging to meet the demands of our customers. It was awarded with ISO/IEC 17025 in 2008.

☉ www.billspec.com.tw
☉ service@billspec.com.tw
威廉特企業股份有限公司



_AD.[263]
WIN POWMAX CORP.

☉ Riveters, Nut Riveters, Caulking Guns, Grease Guns, Air Impact Wrench, Air Ratchet Wrench, Car Repair Tools ☉ We have been a specialized manufacturer of high quality tools & precise parts machining since 1986 with constant research and development, in 2005, we finally developed the cordless tools successfully. We take pride in providing energy saving, durable and productivity enhanced tools to customers. Meanwhile, Winpowmax was set up to handle expanding export business.

☉ www.winpowmax.com.tw
☉ winpow.max@msa.hinet.net
優力克實業股份有限公司



_AD.[041]
WINLINK FASTENERS

☉ Large Nuts, Flanged Head Bolts, Long Carriage Bolts, T-head or T-slot Bolts, Hexagon Head Cap Screws, Wood Screws, Aerospace Screws, Automotive & Motorcycle Special Screws / Bolts, Dowel Screws, Customized Special Screws / Bolts, High Strength Stainless Steel Screws, Square Head Cap Screws ☉ WinLink was established in 1998 and located in Taiwan. In these years, WinLink keeps exporting huge quantities of different kinds of stainless steel and special steel fasteners.

☉ www.winlink.com.tw
☉ sales@winlink.com.tw
岡山東穎開發股份有限公司



武沛金有限公司
WPJ HARDWARE COMPANY



READY FOR WÜRTH?

Do you produce assembly and fastening materials?
你專精於生產高品質組裝件或扣件產品嗎?

Do you have innovations and new ideas?
你的產品有別於他人以及創新的想法嗎?

Do you have production capacities?
你有自備充足而活的產能配置計劃嗎?

Is your main target the professional quality market?
你的主要目標是面向專業及高品質的市場嗎?

THEN YOU MIGHT BE THE FUTURE PARTNER FOR US.

The Würth Group is a world market leader in its core business. It's built its success on fastener products. It currently consists of over 400 companies in more than 80 countries and has over 78,000 employees all over the world. In the core business, the Würth Group, the product range for end and industry comprises over 120,000 products. From various screw accessories and anchors to tools, chemical technical products and personal protection equipment.



_AD.[283]
WISEMETAL ENTERPRISE

☉ Self-drilling Screws, Collated Screws, Sheet Metal Screws, Drywall Screws, Chipboard Screws, Stamped Parts, Customized Special Screws / Bolts, All Kinds of Nuts, Rivets, Tapping Screws, Wood Screws, Machine Screws, Window Screws, Wing Collated Screws, Color Screws ☉ WISEMETAL has been devoted to developing screw drills for years and keeps doing it better continuously in this field. We cherish the feeling of people who using the screws, and also help the house owners to speed up finishing their constructions.

☉ www.wisescrew.com
☉ wise.screw@msa.hinet.net
恆信金屬企業有限公司



WPJ HARDWARE

☉ Solid Sleeves, Solid Bushings
☉ WPJ Hardware Company was founded in 2013. We are the professional manufacturing company of Solid Rollers and Solid Bushing products in Taiwan. The General Manager, Mr. Hsieh Chin-Tsun, has more than 30 years of experience in manufacturing solid sleeves. Our goal is to provide the best quality products, on time delivery and continuous improvement that exceed customers' expectations.

☉ www.wpj.com.tw
☉ info.wpj@msa.hinet.net
武沛金有限公司



WÜRTH (ADOLF WÜRTH)

☉ Customized Special Screws / Bolts
☉ The Würth Group is a world market leader in its core business, the sale of assembly and fastening materials. It currently consists of over 400 companies in more than 80 countries and has approximately 77,000 employees on its payroll. Approximately 33,000 of these are permanently employed sales representatives. According to the annual financial statement, the Würth Group generated total sales of EUR 14.3 billion in the business year 2019.

☉ www.wuerth.com
☉ brian.wu@wuerth.com
德商阿道夫伍爾特有限公司台灣分公司





_AD.[022]
WYSER INTERNATIONAL

● Cage Nuts, Cap Nuts, Clinch Nuts, Flanged Head Bolts, Hexagon Head Bolts, Ball Ended Screws, Ball Screws, Bushings, Automotive Screws, Acme Screws, Alloy Steel Screws, Hook Bolts
 ● Wyser directs its expertise and strength toward engineering fasteners and related parts. Your Specific Needs will be always taken care of and well responded. Wyser is well aware that we must be always in customers' position and know how we can get better assistance for the customers.
 ● www.wyser.com.tw
 ● wyser@wyser.com.tw
 緯聯股份有限公司



XING-SHOW COATING

● Chromium-free Coating, ED Coating
 ● Our company has got ISO 9001: 2015 certification and is devoted to providing coating processing of metal surface with high-quality, high-specification and customization, such as DACORTIZING, Lu Xiubao and Ageis Coating, which are our latest coating technology. After the surface treatment, the fastener can withstand more tests of acid rain, salt spray and weather resistance (UV irradiation).
 ● www.xingshow-coating.com
 ● xingshow.coating@gmail.com
 鑫銹企業有限公司



_AD.[036]
YI CHUN ENTERPRISE

● Cap Screws, Socket Set Screws, Cage Nuts, Clip Nuts, Stamped Parts, Blind Nuts / Rivet Nuts, Automotive Parts, Weld Nuts, Welding T-nuts, U Nuts, A2 Cap Screws, Special Screws
 ● YI-CHUN is an ISO 9001 certified manufacturer. We have over 20 years of experience as one of the leading manufacturers and suppliers of Auto Parts and Specialized Fasteners. We have been exporting our products mainly to European countries, the United States, Japan and Asia for many years.
 ● www.yc-fen.com.tw
 ● fooh.ming@msa.hinet.net
 詠峻實業有限公司



_AD.[115]
YI HUNG WASHER

● Custom Washers, Washers PVC, Small Washers, Teflon® Washers, Nylon Flat Washers, Plastic Flat Washers, Non-metallic Washers, Washers, Vulcanized Fiber Washers, Polypropylene Washers, Polyethylene Washers, Polyester Washers
 ● We were established in Shu-Lin, Taipei in 1995. We guarantee to provide all our customers with the highest quality products, services and on-time delivery. We are a professional supplier of Washers, Screws and Nuts in Plastic, O-rings, Leaf Springs, Terminal and Electronic parts.
 ● www.yh-washer.com.tw
 ● sales@yh-washer.com.tw
 益弘華有限公司



_AD.[060]
YING MING INDUSTRY

● Wheel Bolts, Taptite Screws, Automotive & Motorcycle Special Screws / Bolts, High Strength Bolts, Connecting Rod Bolts, Screw Plug, Heat Resistant Bolts, Aerospace Screws, Alloy Steel Screws, Plastite Screws, High Temperature Screws, Remform Screws
 ● Ying Ming, an expert manufactory of high strength fasteners in Taiwan founded in 1969. With self-contained facilities of heat treatment furnaces, mental finish, and full inspection equipment, Ying Ming manufactures high strength fasteners.
 ● www.ymfastec.com
 ● yingming@ymfastec.com
 穎明工業股份有限公司



_AD.[171]
YING YI CO., LTD.

● Automotive Screws, Machine Screws, SEMS Screws, Stainless Steel Bolts, Combined Screws, Customized Special Screws / Bolts, All Kinds of Nuts, Flange Nuts, Custom Washers, Rubber-to-metal Anti-vibration Sealing Washers, Custom Pins, Tapping Screws, Hardware, Hexagon Head Cap Screws, Lag Screws, Lock Nuts, Non-metallic Washers, Blind Nuts / Rivet Nuts, Alloy Rivets, Self-drilling Screws, TEK Screws, Chipboard Screws, Socket Head Cap Screws, Hexagon Nuts, SEMS Washers, Toothed Washers, Blind Rivets.
 ● www.yingyi-fastener.com.tw
 ● fredying@ms61.hinet.net
 穎翊股份有限公司





_AD.[056]

YOUR CHOICE FASTENERS & TOOLS

☉ Chipboard Screws, Drywall Screws, PVC Screws, Roofing Screws, Self-drilling Screws, A2 Cap Screws, Collated Screws, Self-Tapping Screws, ZDC Cap Screws, Wing Screws, Farmer Screws, Machine Screws
 ☉ YOUR CHOICE, is a well-known and professional construction screws manufacturer in Taiwan. We develop & produce difference kinds of standard or special screws and export to the global market. In the past 4 years, we started to produce accessory tools to broaden our product range.

☉ www.ycs.com.tw
 ☉ taitzu.taitzu@msa.hinet.net
 太子螺絲股份有限公司



_AD.[450]

YOW CHERN CO., LTD.

☉ Flanged Head Bolts, Chipboard Screws, Floorboard Screws, PVC Screws, Self-drilling Screws, Plastite Screws, Machine Screws, Hose Clamp Screws, PT Screws, Anchor Bolts, Automotive Screws, Wood Screws
 ☉ Automobile and special parts are usually produced by cold forming with multi-station machines, especially 5 and 6 stations. High strength bolts and anchor system are also our main products. We can make different kinds of products such as wheel bolts, hammerhead bolts, welding bolts and special nuts.

☉ www.yowchern.com.tw
 ☉ ycsales@yowchern.com.tw
 恆城股份有限公司

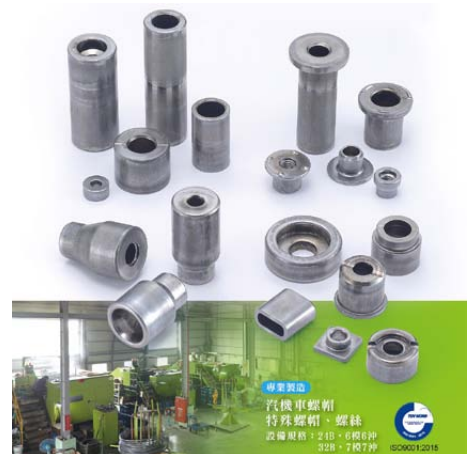

_AD.[366]

YU RUEN HARDWARE

☉ Automotive Nuts, Automotive Screws, Special Screws, Special Bolts, Automotive Fasteners, Customized Nuts, Special Screws or Bolts
 ☉ Yu Ruen founded in 1912 kept progressing in the past 8 years and has become a world-class supplier of special cold forged nuts. The company started as a fastener trader and began to manufacture nuts in response to clients' demand. It grew from a small factory into one with 300-ton monthly capacity and strict quality control.

☉ www.yuruen.com.tw
 ☉ yu.ruen@msa.hinet.net
 裕潤五金有限公司



_AD.[064]

YUH CHYANG HARDWARE INDUSTRIAL

☉ Turning Parts, Customized Special Screws / Bolts, Special Parts, Automotive Parts, Automotive & Motorcycle Special Screws / Bolts, Automotive Screws
 ☉ Yuh Chyang Hardware Industrial Co., Ltd., founded in 1991, is fulfilling its promise to provide the most suitable solutions to all customers' requirements in the hardware field. We are based on "deliberate production skill, operational improvement, and endless innovation".

☉ www.yuhchyang.com
 ☉ yc.cnc@msa.hinet.net
 鈺強五金實業有限公司



_AD.[146]

YUN CHAN INDUSTRY

☉ Hex Keys, Socket Bit Sets, Wrench Sets, Tool Kits, Bit & Bit Sets, Nut Setters, Socket Bits, Sockets, Bit Sets
 ☉ Established in 1976, YUN CHAN has continually provided professional, customer-friendly service and superior quality products to our worldwide clients. We are the leading manufacturer for portable and industrial quality Screwdriver Bits, Screwdrivers, Allen Key, Impact Driver, Nut Setter, Bit Holder and Ratchet Drivers. YUN CHAN are 100% made in Taiwan.

☉ www.yunchan.com.tw
 ☉ jhaiso@ms32.hinet.net
 雍昌工業有限公司



_AD.[106]

YUNG KING INDUSTRIES

☉ Dowel Pins, Roll Pins, Self-locking Pins, Split Pins, Spring Pins, Internal Tooth Washers, Wave Spring Washers, Retaining Ring, Cotter Pins, Hammer Lock Cotter Pins, Quick-Insert Cotter Pins, Slotted Spring Pins, Toothed Spring Pins, Hitch Pin Clips, Snap Pins, External Hitch Pins, Special Hitch Pins & Clips, Special Washers
 ☉ In 1960, we established our small family factory at Taipei County to be a specialized manufacturer of Cotter Pins with steel and to be a supplier of hardware wholesaler.

☉ pinyuking.com.tw
 ☉ yuking@seed.net.tw
 榮金工業有限公司





▲ 三價鉍鎳
zinc-nickel / trivalent chromate



AD.[434]
ZONBIX ENTERPRISE
 ● Wheel Nuts, Eye Bolts, T-head or T-slot Bolts, Wheel Bolts, Self-drilling Screws, Double-head Screws / Bolts, Self-locking Nuts, Nylon Insert Nuts, Nylon Cap Insert Lock Nuts, Screw Plug, Hydraulic Components, Hammer Bolts, Double End Studs, and Thread Inserted Components ● Located in southern Taiwan and the regional hub for fasteners in Asia - we work closely with over 100 manufacturing partners in our network to serve the complex global fastener market with quality and diversity.
 ● www.zonbix.com.tw
 ● ZNB@zonbix.com.tw
 琮比企業有限公司



AD.[188]
ZYH YIN ENT. CO., LTD.
 ● Dowel Pins, Chipboard Screws, Drywall Screws, Floorboard Screws, Furniture Screws, Wood Screws, High Low Thread Screws, Roofing Screws, Hexagon Washer Head Screws / Bolts, Tapping Screws, Deck Screws, Customized Special Screws / Bolts
 ● ZYH YIN located in Kaohsiung in Southern Taiwan, R.O.C is a manufacturer of fasteners & hardware, especially screws, bolts & nuts for wooden furniture. Established in 1980, we have been providing our products to our customers worldwide.
 ● www.zhyin.com
 ● jaime@zhyin.com
 至盈實業股份有限公司

AD.[369]
Z&D PLATING CO., LTD.
 ● Zinc Plated, Lubricant, Surface Treatment and Related Equipment, Water-based Lubricant ● Z&D Plating Co., Ltd, founded in 2002, specializes in providing high quality, precision barrel plating finishes, specifically Zinc (Zn) and Zinc-Nickel (ZnNi) alloy. We are an IATF 16949 certified electroplating factory for the automotive industries, meanwhile continually elevating itself by making improvements in every aspect to stay ahead of its competitors and keep up its long built reputation.
 ● www.zdx.com.tw
 ● ruida.xin@msa.hinet.net
 瑞達信興業股份有限公司

Company Focus

New Factory Supplying Premium Self-locking Nuts
Simmonds Marshall Ltd. *by Dean Tseng, Fastener World*

Simmonds Marshall, an Indian pioneer in manufacturing and supplying specialty nuts (mainly self-locking nuts), bolts and studs, was established in 1960 and now has 1,050 employees generating a revenue of US\$30 million. It is a 60-year automotive OEM exporting products to the UK, USA, Europe, South Africa and worldwide.

Streamlined, Customizable and Quality-guaranteed Manufacture

The company's production is streamlined and done in-house starting from forging, secondary operations (tapping/rolling, crimping, machining, closing) to heat treatment and finally surface treatment (plating). It constantly works with customers to tailor-make products suited for their requirements and all products are manufactured to specific customer drawings/standards, maintaining the highest quality standards. Simmonds Marshall is TS 16949 and ISO 14001 certified and regularly audited by esteemed customers worldwide who demand top quality. It has a strong engineering and R&D team who constantly work on improving and maintaining high standards.

New Factory in Pune and Acquisition of Philidas

By appearing on Fastener World Magazine, the company is excited to announce that earlier this year it built and moved to a new state-of-the-art factory in Pune, India. The factory space spans 120,000 square feet including a new high-end heat treatment and plating facility. A few years back it also acquired Philidas (UK-based specialty nut manufacturer for global railway industry) whose industrial and turret nuts are renowned as a superior self-locking nut alternative, widely used by UK Rail and other prestigious customers worldwide.

Catering to Demand Uptick Onward to 2021

"While COVID-19 has badly affected demand from April till date, we are seeing signs of a significant uptick in demand domestically and overseas. Our hope is that this trend will continue

and sooner rather than later this pandemic will be behind us," said managing director Navroze Marshall. Particularly with Taiwan, Simmonds Marshall has had business ties with the country for 40 years. "Many of our machines and tooling have been sourced from Taiwan. We are always looking for partners who either would like us to supply our wide range of products to the overseas markets or would like to partner with us in entering the Indian market."

As the next step for 2021, the main focus of Simmonds Marshall is to cater to this demand and continue to grow with existing customers, while always being on the look out for new customers to develop and work with. ■



Contact: Navroze Marshall, Managing Director
 Email: nmarshall@simmondsmarshall.com



_AD.[335]

AN CHIAO MOLDS

Tooling for Forming Machine, Square Punches, Hexagon Punches, First Punch Dies, Multi-die Punches, Cutting Dies, Header Toolings, Tungsten Carbide Die, Segmented Hexagon Dies, Punches, Second Header Punches, Second Punch Cases, Carbide Dies, Dies for Multi-Stage Forged Fasteners, Fastener-Cold-Forming Dies, Hexagonal/Square Heading Dies, Dies for Tribular Screws, Punch Dies, Carbide Quill...

www.an-chiao.com.tw

chen.chinjen@msa.hinet.net

安喬模具有限公司



BUYERS' GUIDE

Machinery, Tooling and Others

2021

Sampling Onsite and Storage Record

Independent Quality Inspection Services in Asia

ISO 17025 Length & Torque Calibration Lab (ISO 17025 認可 長度&扭力校正實驗室)

Calibration Range : Torque: 0.4 Nm ~ 1000 Nm
Ring Gauge: M2.5 ~ M150
Plug Gauge: 0.05 mm ~ 150 mm

_AD.[117]

ASIA TECHNICAL SERVICES

Water-based Lubricant, Automotive Parts, Torque Wrench, Torque Sensor Calibration, Torque/clamping Force Testing System, Spec Inspection, Schatz Torque/clamping Force Testing System, Ring Gage, Thread Gage, Plug Gage Calibration, Length Calibration, Fastener Testing And Inspection-laboratory, Measuring Tools, Heat Treatment Furnace

Asia Technical Services is an independent third party of inspection & calibration services.

www.asiatec.com

info@asiatec.com

亞東公證有限公司



gmi, SGS, Fogra cert, 20445, 德國色彩認證

GMI Label

Anti-counterfeiting Pattern Coating, Multi-Purpose Screens, Cold Foil Hybrid Coating, Hybrid Coating, Anti-counterfeiting Pattern Coating

BAO-FA
專業標籤印刷
Professional label printing
紙卡、吊卡印刷
paper card.elevator printing

_AD.[297]

BAO FA LABEL PRINTING

Professional Label Printing, Paper Card & Elevator Printing

Since it was established, Bao Fa has been well-reputed for its labels of optimal adhesiveness and best-in-class manufacturing efficiency in the industry and has produced a variety of printed self-adhesive trademarks, color stickers, poly stickers, automatic labels and stickers, etc. We are constantly devoted to researching and developing processing techniques.

www.labels.com.tw

hsin.sheng@msa.hinet.net

寶發特殊印刷有限公司



BEST QUALITY WIRE
上冠品有限公司
FMWT CO., LTD.
金冠群五金科技有限公司

Resource Recycling!
Reducing Industrial Waste!

BEST QUALITY WIRE

Alloy Steel Wire & Rod, Carbon Steel, Stainless Steel Wire & Rod, Vacuum Heating Oil Filter, Iron or Steel Wire Rod, DRILL13(550), A286, Automatic Sludge Separator, Electrolytic Polishing and Grinding Machine, Fine Particle Oil Sludge Filter

Best Quality Wire was established in 2004. We are a company in Taiwan which supplies the wire rod for the bolts, nuts and fastener manufacturers. Due to stable quality, reasonable price and good service, our company has a high reputation.

www.fmwt.com.tw

sales@bqw.com.tw

上冠品有限公司



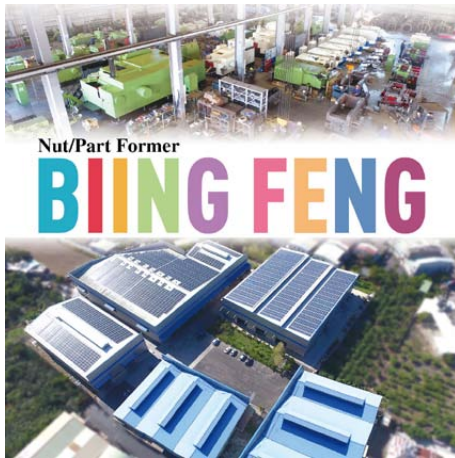

_AD.[311]
BIING FENG ENTERPRISE

Blind Nut Formers, Set Screws Formers, Sockets Formers, Multi-station Cold Forming Machine, Parts Forming Machine, Nut Formers, Rollers Formers, Screw (Bolt) Formers ☺ Our company has been 40 years old (Since 1976). Our main products are Nut Formers & Parts Formers (from 11B to 50B). Our P.K.O System is special, patented and different from others in the world. Our formers can produce Nut, Roller, Rivet, Socket, Rivet Nut, Set Screw and other special parts.

www.bf-bestformer.com
bf@bestformer.com
秉鋒興業股份有限公司



_AD.[318]
CHAN CHANGE MACHINERY

Blind Nut Formers, Blind Rivet Heading Machine, Set Screws Formers, Hexagon Pin Punch, Multi-station Cold Forming Machine ☺ CHANG HORNG is a well-reputed manufacturer of screw heading machines which allow our clients to design or create numerous types of screw heads and drive inserts. We cultivate professionalism in 2 die 4 blow, 3 die 6 blow and cold forming machine from 3 die 3 blow, to 6 die 6 blow. In 2020 we also added the 1 die 2 blow high speed heading machine.

chan-change.com
info@chan-change.com
長善機械有限公司



_AD.[357]
CHAO JING PRECISE MACHINES

Cold Forge Forming Machine, Parts Former, Heading Machine, Thread Rolling Machine ☺ Chao Jing is based on innovative technology and excellent quality of core competencies, and provide the most sophisticated fasteners and the most reasonable price, "Customer first, Quality first". Chao Jing will continue in line with the original spirit of service to serve the public; towards internationalization and diversification.

www.chaojing.com.tw
jw.zw@msa.hinet.net
朝環精機有限公司



_AD.[364]
CHEN TAI FASTENER MACHINE

Vibratory Bowl Feeders, Metal Roll Marking Machine, Automatic Elevator Conveyor, Vibratory Feeder Fillings, Accessories, Digital Slanting Disk Screw & Washer Assembly Machine, Feeding System for Grinding, Feeding System for Nut Tapping, Roller Type Sorting Machine Set, Filling Feeder, Arraying Feeder, Double Ended Stud Orientation Machine, Orientation Pushing Forward Device, Automatic Feeding Robot Arm, Long Tube, Long Sleeve Auto Two End Select Orientation Machine + Lathe Full Set Feeder Series

www.jenntai.com.tw
chentai@jenntai.com.tw
成太機械有限公司



_AD.[343]
CHENG FANG YUAN MACHINERY INDUSTRIAL

Hi-speed Auto Thread-tapping Machine, Arraying Feeder, Filling Feeder, Global Abrasive Machine, Ball Filling Feeder, Nut Cleaning Machine ☺ Established: APRIL 1994; Professional manufacturer of Tapping Machine. Continuous innovation, to provide a better way of life and a better working environment for mankind, to achieve the goal of continuous operation through practices of professional excellence, working enthusiasm, and enterprise responsibility.

www.cfy.com.tw
besttapping@gmail.com
正方元機械工業有限公司



_AD.[362]
CHIEN SEN WORKS

Solid Carbide Punches, 12-Point Punches, Hexagon Punches, Round Pin Punches, Six-Lobe Punches, Special Punches ☺ Chien Sen was established in 1995 as a professional carbide pin factory in Taiwan. Its carbide tooling is used in screw & nut industry, car industry, aerospace industry...etc. Chien Sen company always keep innovating and improving technology to meet customer's needs. Chien Sen company is your best choice!

www.chiensen.com.tw
e7874471@ms54.hinet.net
千森機械企業有限公司





_AD.[327]

CHIEN TSAI MACHINERY ENTERPRISE

Ⓢ Thread Rolling Machine (High Speed Automatic Thread Rolling Machine 30° Feeding, Automatic Thread Rolling Machine 90° Feeding), Double-bar Type Iron Chip Separator, Store Hopper, Conveyor, Inverter, Screw Washer Assembling Machine, Screw Point Cutting Machine, Slotting Machine

Ⓢ Chien Tsai was founded in 1973 in Taiwan, which is a professional manufacturer of thread rolling machines and slotting machines.

Ⓢ jiancai.com.tw

Ⓢ jiancai@jiancai.com.tw

鍵財機械企業股份有限公司



_AD.[316]

CHING CHAN OPTICAL TECHNOLOGY

Ⓢ Optical Sorting Machine, Eddy Current Sorting Machine, Optical Measurement Instrument, Fastener Maker, Screw (Bolt) Formers Ⓢ CCM established in 1992 and headquartered in Kaohsiung, Taiwan. CCM not only has the world's first intelligent production line integration technology, from forming, oil centrifuge, thread rolling to terminal optical sorting and on-line real-time monitoring, but also implement AGV system to create the best tool for customers in industry 4.0.

Ⓢ www.ccm3s.com

Ⓢ sales@ccm3s.com

精湛光學科技股份有限公司



HIGH SPEED BOLT POINTER HC-P14

HAICHUAN

Diameter: Ø3 - Ø15mm
 Length: 12 - 150mm
 Max. Speed: 150pcs/min

**POINTING
 DRILLING
 CHAMFERING**

MADE IN TAIWAN

CHUM YUAN (CYC)

Ⓢ Open Die Machine, Nuts Tapping Machine, Nut Formers, Thread Rolling Machine, Straightening Machine, Screw (Bolt) Formers, High-speed Centrifugal Oil Filter, Buy And Sell Used Fastener Machinery, K.O. pins, Jigs, Header Punches, Tungsten Carbide Tools and Cutters Ⓢ Chum Yuan is a service oriented company which has over 40 years of experience in providing Industrial Machinery, Forming Tools, and related products. CYC was established in 1980 in Taiwan.

Ⓢ www.chumyuan.com

Ⓢ info@chumyuan.com.tw

琛元企業有限公司



CK-601
 阶梯式自动送料油压矫直机
 STEPPED AUTOMATIC FEEDING
 HYDRAULIC STRAIGHTENING MACHINE

CK-900
 平板整平机
 FLAT PLATE
 SMOOTHENING MACHINE

CK-230
 钢管矫直机
 STEEL PIPE
 STRAIGHTENING MACHINE

_AD.[332]

CHUN KAI MACHINERY

Ⓢ Straightening Machine Ⓢ Chun Kai was established in 1986 to make automatic machinery spindles and various automatic equipment, such as, hydraulic straightening machine, flat plate straightening machine, straightness measuring instruments and go through straightening machine with many years of experiences. In 1995, the company launched correction series of products for round, angled, irregular shapes and plates materials and started to take OEM orders.

Ⓢ www.chunkai.com.tw

Ⓢ ck23356525@chunkai.com.tw

駿凱機械有限公司



CHUN ZU MACHINERY
 ISO 9001 春日機械工業股份有限公司

CBF/CBP/CNP Three, Four, Five and Six Blow Bolt and Nut Parts Formers

_AD.[314]

CHUN ZU MACHINERY INDUSTRY

Ⓢ Tooling For Forming Machine, Trimming Dies, Cold Header, Thread Rolling Machine, Heading Machine, Mini-formers, Nut Formers, Parts Forming Machine, Multi-station Cold Forming Machine, Header Toolings, Thread Rolling Die Plates, Bolt and Nut Parts Former, Thread Dies Ⓢ Established in 1973, Chun Zu is an affiliate of Chun Yu Group and is known worldwide for our "Lion" trademark products. Our staff is committed to achieving our goal of providing exemplary products.

Ⓢ www.chunzu.com.tw

Ⓢ info@chunzu.com.tw

春日機械工業股份有限公司



COS TOOL

_AD.[333]

COS PRECISION TOOL

Ⓢ Customerized Punches, Carbide Punches, CNC Turning Parts, Carbide Dies, Header Punches, Cutting Dies, Serration Dies, Die Sets, Carbide Dies, Punches Ⓢ At the beginning, COS was a factory specialized in making OEM&ODM precision tools for other brands. Backed by over 20 years of precision tools making experience COS Precision co., Ltd. decided to establish its own exporting operation in 2012 and to launch its business internationally with its own brand.

Ⓢ www.cos-tool.tw

Ⓢ info.cos@msa.hinet.net

怡豐實業有限公司





DAH-LIAN MACHINE

● Fastener Maker, Thread Rolling Machine, Heading Machine, Screw Washer Assembling Machine, Nut Formers, Nuts Tapping Machine, Straightening Machine, Self-drilling Screw Forming Machine, Long Self-Drilling / Tapping Screw & Washer Assembly Machine, Screw (Bolt) Formers, Automatic Thread Slotting Machine ● We are professional in manufacturing machines for fastener production and special designed machines.

● www.screwmachine.com.tw
● dahlian@ms25.hinet.net
大連機械工業有限公司



E-UNION FASTENER

● Self-drilling Screw Forming Machine, Tooling for Forming Machine, Thread Rolling Machine, Automatic Conveying System, Automatic Thread Slotting Machine, Multi-station Cold Forming Machine, Heading Machine, Heat Treatment Furnace, Open Die Machine, Tungsten Carbide Die, Diamond, Cbn Tools and Cutters, Surface Treatment And Related Equipment ● We are specialized in supplying the fastener making machines, tooling, related equipment, stamping parts.

● www.fastener-world.com/en/supplier/e-union
● eunion.edward@msa.hinet.net
奕盟企業有限公司



FRATOM FASTECH

● First Punch Dies, Carbide Dies, Carbide Pins, Header Punches, Header Toolings, K.O. pins, Knives, Multi-die Punches, Tungsten Carbide Die, Second Punch Cases, Hex Recess Punches, Tungsten Carbide Tools and Cutters ● FRATOM FASTECH established in 2015, located in Kaohsiung, Taiwan. With a production team of over 20 years in manufacturing experience and a highly trained dynamic team, we are uniquely equipped to satisfy your performance requirements.

● www.fratom-fastech.com
● info@fratom-fastech.com
福敦科技有限公司



GIAN-YEH INDUSTRIAL

● Pointing dies, Self-drilling dies, Tungsten Carbide Die ● We are a manufacturer of DP dies and drill screw molds in a full range of sizes. We have been in this field of producing and sales of screw molds for more than ten years. We can offer the cutter diameter 2.1mm to 10.8mm by 0.05mm of the increment, and the length from 1.5mm to 23.5mm by 0.1mm of the increment. We can also produce any feature according to customer's request.

● www.gian-yeh.com.tw
● m2212307@ms27.hinet.net
健業模具廠有限公司



GWO LIAN MACHINERY INDUSTRY

● Wire Drawing Machine, Straightening Machine, Wire Processing Machinery, Combined Descaling Machine, Steel-Brush Type Descaler, Automatic Wire Feeding & Shaving Machine For Wire Rod, Non-Stop Coiler for Skinpass, Pay-Off Equipments, Equipments for Stainless Steel Wire ● Gwolian Machinery was established in 1968. With its own unique features (patents), Gwolian has reached the sales volume of more than 4000 sets and has gained ISO-9001 and CE certification.

● www.gwolian.com
● sales.dept@gwolian.com
國聯機械實業股份有限公司



GWO LING MACHINERY

● Blind Rivet Heading Machine, Thread Rolling Machine, Ball Header Cold Forming Machine, Heading Machine, Hollow Heading Machine, Screw Washer Assembling Machine, Semi Tubular Rivet Machine, Mirco Heading Machine, Screw (Bolt) Formers, Chip Sorting Machine, Automatic Thread Slotting Machine, Cold Header ● Established in 1980, Gwo Ling is operated by President Hsin-Yi Cheng. With industrious employees and advanced technology.

● www.gwoling.com.tw
● gwoling@ms39.hinet.net
國菱機械有限公司



New And Used Fastener Equipment Dealer
Your most reliable supplier to all fastener solutions.

OUR SELLING EQUIPMENT



_AD.[353] HONG FU METAL INDUSTRIAL

☉ Buy and Sell Used Fastener Machinery, Cold Header, Nut Formers, Screw (Bolt) Formers, Assembly Machine ☉ New and Used Fastener Equipment Dealer. Used fastener supplier. Hong Fu Metal is a reliable used fastener machinery supplier from Taiwan. We are professional in exporting used fastener equipment to the world. Our major products include Heading Machine, Thread Rolling Machine, Cold Bolt Former, Nut Former, Hex Head Trimming Machine, etc.

☉ www.fastener-machine.com
☉ hongfu1688@gmail.com
鴻富金屬工業有限公司



_AD.[342] HONG TAY YUE ENTERPRISE

☉ Centrifugal Deoiler, Wire Straightener, Arraying Step Feeder, Sorting Roller with Box Packing System, Hydraulic Press for Carbide Nib Replacement, Wire Lifting Platform, Industrial Parts Washer (Rotary Drum), Conveyor Parts Washer (Agent Wanted) ☉ Since our foundation, we have been dedicated to design and production of industrial machinery. We produce diverse equipment, such as Professional Centrifugal Casting Machines and Peripheral Equipment used in fastener...

☉ www.hongtayu.com.tw
☉ hong.tayu@msa.hinet.net
鴻大裕企業有限公司



_AD.[361] INFINIX PRECISION

☉ Carbide Dies, Carbide Pins, Header Punches, Header Toolings, K. O. Pins, Molds & Dies, Punches, Segmented Hexagon Dies, Tooling for Forming Machines, Tungsten Carbide Dies, TORX Punches, Multi-die Punches ☉ Infinix is a privately-held, ISO 9001 certified company formed by a dedicated team with more than 30 years of experience in tools manufacturing. We offer a portfolio of tooling such as punches, dies, cutters, fingers, pins, and other general forming tools.

☉ www.infinix.com.tw
☉ tooling@infinix.com.tw
英飛凌股份有限公司



Your One-Stop Solution for Professional Quality Management!

解決您有關專業品質管理的最佳選擇!



iTAC LABORATORY

☉ Fastener Testing and Inspection-laboratory, Spec Inspection, Factory Audits, PPAP Documentation Consulting, Sample Pickup, Quality Consulting, Quality Training, Fastener Training, Customized Test Solutions. Laboratory Outsourcing and Subcontracting ☉ iTAC was founded in 2005 and earned its TAF certificate (equivalent to A2LA) in 2006. iTAC testing laboratory provide an accredited third party lab inspection report, and also provide many other quality related services.

☉ www.itac-lab.com.tw
☉ cchang@itac-lab.com.tw
鼎誠扣件科技股份有限公司



_AD.[184] JENG YUH CO., LTD.

☉ Packing Box ☉ JENG YUH was founded in 1988 and located in Taiwan. All kinds of plastic injection products, plastic mold R&D, product design and material trading. Core value: Speedy, Quality, Flexibility and Cost saving. Contact us to customized your needs! Professional plastic injection factory producing various plastic containers for hardware, packaging buckets for screws, plastic cans for food, pudding cups, food containers, stationery, tableware, and storage supplies.

☉ en.plastic-packagingbox.com
☉ jeng.yuh@msa.hinet.net
政毓股份有限公司



_AD.[452] JERN YAO ENTERPRISES

☉ Blind Nut Former, Nuts Tapping Machine, Set Screws Former, Sockets Former, Cold Header, Multi-station Cold Forming Machine, Thread Rolling Machine, Nut Former, Parts Former, Rollers Former, Screw (Bolt) Former, Warm Former ☉ Jern Yao was formed in 1993. Jern Yao is one of the largest forming machine builders in the world building over 180 machines a year. Jern Yao has an outstanding reputation in their field providing a high level of technology, quality, service and value.

☉ www.jernyao.com
☉ sales@jernyao.com
正耀企業股份有限公司





AD.[350] JIENG BEEING ENTERPRISE

Tooling for Forming Machines, Carbide Dies, Square Punches, Hexagon Punches, Trimming Dies, First Punch Dies, Phillips Punches, Global Patent Licensing (Mathread®, Uni-Screw, Conti Screw, Robertson Screw Mold), Flat Thread Rolling Dies for Machine Screws, Second Punches, Heading Dies, Drill Point Dies, K.O. Pins, Cut-off Knives
 Jieng Beeing, a leading screw mold supplier in Taiwan, as JP brand well known in the world.
 www.jpmetalgroup.com.tw
 susantung@mail.jpmetalgroup.com
 精斌企業股份有限公司



AD.[341] KEIUI INTERNATIONAL

Self-drilling Screw Forming Machines, (Pinch Pointer) with "4 in 1" function suitable for making both Stainless Steel and Carbon Steel Screws.
 KU Machinery is a professional manufacturer specialized in making Self-Drilling Screw Forming Machines (Pinch Pointer). We obtained 12 patents for KU's pointers, and always make efforts on R&D for better machine performance for users.
 en.keiui.com.tw
 info@keiui.com.tw
 鎧滄國際企業有限公司



AD.[337] KIM UNION INDUSTRIAL (UNION)

Acme Screws, Ball Screws, Headless Set Screws, Knurled Head Screws, Left-hand Screws, Thread Rolling Screws, Thread Forming Screws, Thread Rolling Machines, Assembly Captive Screws, Cam Thread Rolling Dies, Gear Serration Rolling Machines, Hydraulic Thread Rolling Machines, Serration / Knurling Rolling Die
 Kim Union has been in the industry since 1972, and is now the only firm in Taiwan to manufacture both thread rolling dies and thread rolling machines.
 www.kimunion.com
 kimunion@kimunion.com
 金友聯工業股份有限公司



AD.[352] KING YUAN DAR METAL ENTERPRISE

Heat Treatment Furnace
 Established in 1980, KING YUAN DAR is nowadays one of the largest industrial gas suppliers in Taiwan. Due to the strong connection between gas industry and heat-treatment, the founding chairman built up his 1st reinvestment heat-treatment factory in 1999 named KING YUAN DAR METAL (Zhangbin plant) with his specialized knowledge in gas.
 www.fastener-world.com/en/supplier/kyd
 pdaiboo@kydmetal.com
 金元達金屬股份有限公司



AD.[340] KINGSYEAR CO., LTD.

Nuts Tapping Machines, Carbide Pins, Tooling for Forming Machines, Carbide Dies, Square Punches, Hexagon Punches, Thread Rolling Die Plates, Trimming Dies, Hex Recess Punches, Multi-station Cold Forming Machines, Wire Drawing Machines
 KINGSYEAR was founded in 1998 with the commitment to supply our customers with superior quality tooling. Our quality policy is to continually improve ourselves and exceed our customers' expectations.
 www.kingsyear.com
 sales@kingsyear.com
 金祥億有限公司



AD.[323] KUANG TAI METAL INDUSTRIAL

Stainless Steel Wire & Rod
 Professional wire manufacturer for various applications since 1978 with carbon steel, low alloy, stainless steel and nickel alloy grades in Taiwan. Kuangtai Metal Industrial was established in 1978 as a welding wire manufacturer. After 40 years of growth, Kuangtai Metal has become a leading company in the welding consumable and stainless steel wire industries, based on our strong knowledge of welding and wire drawing.
 www.kuangtai.com
 edwardchen@kuangtai.com
 廣泰金屬工業股份有限公司



Specialize in
Drilling Point Molds
 for carbon steel / stainless steel / bi-metal screws

ODM as per customer's demand

www.fastener-world.com/en/supplier/kochen/
 KuoChenMold@gmail.com
 國鎮模具有限公司

_AD.[356]

KUO CHEN MOLD

☉ Pointing Dies, Self-Drilling Dies, Drilling Point Molds for Carbon Steel / Stainless Steel / Bi-metal Screws.
 ☉ Specialize in Carbon Steel, Stainless Steel Bi-Metal Screws. ODM as per Customer's Demand

☉ www.fastener-world.com/en/supplier/kochen/
 ☉ KuoChenMold@gmail.com
 國鎮模具有限公司



Rustproof Treatments for Metallic Parts is Our Specialty

Automatic Dip Spin Line
 Mechanical Galvanizing Line
 Hot Dip Galvanizing Line

自動浸旋塗裝系統
 機械鍍鋅
 熱浸鍍鋅

Applications:
Rustproof treatments for fasteners and metallic products
 We can also design and make whole plant coating equipment according to customers' special requirements.

www.lydsauto.com.tw
 lydsauto@ms54.hinet.net
 利運機械股份有限公司

_AD.[346]

LI YUN MACHINERY

☉ Hot Dip Galvanizing
 ☉ LI YUN MACHINERY CO., LTD. is dedicated in "Spinning and Coating System, Coating Equipment, Surface Treatment Equipment, Metal Melting and Processing Equipment, Hardware Parts Treatment Equipment, Spinning and Coating System, Coating Equipment", with operations in Taiwan.

☉ www.lydsauto.com.tw
 ☉ lydsauto@ms54.hinet.net
 利運機械股份有限公司



連翔工業
 LIAN SHYANG INDUSTRIES

連翔工業，品質卓越
 LIAN SHYANG INDUSTRIES, EXCELLENT QUALITY.

點鑽式鑽機組裝機
 Pneumatic & spinolas Tapping Machine

自動凍結式立機
 Automatic Cold Former

www.lian-shyang.com.tw
 lianshyangind@gmail.com
 連翔工業股份有限公司

_AD.[445]

LIAN SHYANG INDUSTRIES

☉ Nut Formers, Nuts Tapping Machine, Multi-station Cold Forming Machine ☉ Lian Shyang was established back in 1978. We are a professional manufacturer of Cold-Forming machines. We serve automobile and bicycle industries. We also produce roller parts and roller related parts. We produce tooling by ourselves to cut down the cost and promote our production efficiency. If you have any production related questions, please don't hesitate to contact us.

☉ www.lian-shyang.com.tw
 ☉ lianshyangind@gmail.com
 連翔工業股份有限公司



Technology Leadership in the Manufacturing Industry

www.headingmachine.com.tw
 zh60420@ms39.hinet.net
 聯騰工業股份有限公司

LIAN TENG MACHINERY INDUSTRY

☉ Cold Header, Fastener Maker, Heading Machine
 ☉ Founded in 1968, Yih-Wen is an iron works factory committed to delivering quality equipment and providing excellent customer service. Yih-Wen built its reputation around the ideals of innovation, precision, and perfection – a "better than best" alternative to existing competitors. These ideals later became the three core values by which the Yih-Wen management and employees conduct business with partners.

☉ www.headingmachine.com.tw
 ☉ zh60420@ms39.hinet.net
 聯騰工業股份有限公司



Quality | Precision | Steadiness!

www.lu-yi.com
 n7350717@ms77.hinet.net
 如翌企業股份有限公司

_AD.[336]

LU-YI DIE WORKS

☉ Drill Point Dies, Self-drilling Dies
 ☉ Lu-Yi established in 1988, Lu-Yi has been dedicated to the R&D and manufacture of drill point dies for 30 years. We always stick to the spirit of "satisfying each client's demand". For being pioneer of the industry, in 2018 we obtained the ISO 9001 Quality System Certificate and are a specialized drill point die manufacturer with certification. All our pursuit is to every client's satisfaction.

☉ www.lu-yi.com
 ☉ n7350717@ms77.hinet.net
 如翌企業股份有限公司



Engineering in Lubricant

microGLEIT®
 Innovative Schmierstoffe
 摩特立科技水性潤滑劑
 microGLEIT Technology Company

www.microgleit.com
 services@microgleit.com
 摩特立科技有限公司

_AD.[113]

MICROGLEIT TECHNOLOGY

☉ Rust Preventative Oil, Water-based Sealer, Lubricant, Surface Treatment And Related Equipment, Water-based Lubricant, Aluminum Bolts, Industrial Robots & Accessories

☉ microGLEIT is a German high tech chemical company, well known for its outstanding water-based lubricants. microGLEIT products have been widely welcomed by automobile industries, screw manufactures and plating manufacturers worldwide.

☉ www.microgleit.com
 ☉ services@microgleit.com
 摩特立科技有限公司





NEW BEST WIRE INDUSTRIAL

● Iron or Steel Wire Rods, Alloy Steel Wire & Rods, Stainless Steel Wire & Rod, Concrete Screws, Carbon Steel Screws, High Low Thread Screws, Metric Screws, Roofing Screws, Hexagon Head Cap Screws, Automotive Parts, Stainless Steel
 ● New Best Wire is currently within top 2 wire drawing manufacturers in Taiwan and also a public listing company. We are certified to ISO 9001 & IATF 16949. We provide products with high quality and reasonable pricing.

● www.newbest.com.tw
 ● newbest@newbest.com.tw
 強新工業股份有限公司



POINTMASTER MACHINERY

● Self-drilling Screw Forming Machines
 ● Established in 1998, PointMaster is a professional manufactory of Self-Drilling screw forming machines. Depending on the creative principle and customer's request, PointMaster has many patents for Self-Drilling screw forming machine. The "Double-Clutch" control system is the most popular design. For Self-Drilling screw forming machine, we are not only the leading brand in Taiwan, we also export our machines.

● www.pointmaster.com.tw
 ● tforever@ms29.hinet.net
 昶詠機械股份有限公司



SACMA LIMBIATE S.P.A.

● Cold and Warm Forming Machines, Netshape Part Formers, Thread Rolling Machines
 ● The commitment to excellence and innovative solutions for cold and warm forming technologies. SACMA designs and builds machines in a manufacturing facility that the industry considers to be the most modern and best equipped in the world. At a time when many of our competitors are relocating their production to lowcost countries, we, in order to guarantee our undisputed quality, are expanding our manufacturing facilities in the "Italian Fastener Valley".

● www.sacmagroup.com
 ● info@sacmagroup.com

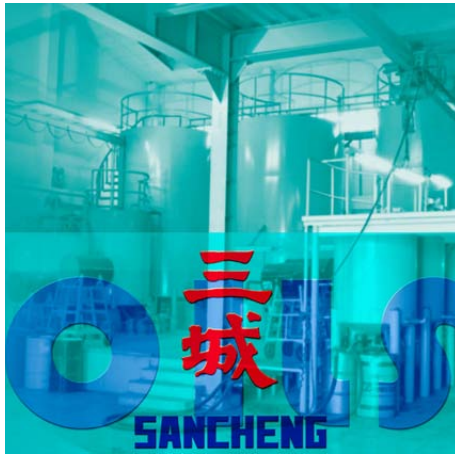

SAN TZENG ENTERPRISE

● Forming Oil, Tapping Oil, Bolt Stamping Oil, Nut Forming Oil, Metal Working Oil
 ● San Tzeng sticks to the managing strategy that the more competitive strengths you own, the more markets you earn, and the managing principle-High Quality and Professional Service- to run its business. By researching aggressively and offering the most competitive products, San Tzeng is a professional supplier of tapping and forming oil.

● www.fastener-world.com/en/supplier/san-tzeng
 ● san.cheng@msa.hinet.net
 三城企業有限公司



SAN YUNG ELECTRIC HEAT MACHINE

● Heat Treatment Furnace, Annealing Furnace, Quenching Furnace, Surface Treatment and Related Equipment
 ● San-Yung established in Taiwan in 1970 is the biggest mesh belt type continuous furnace manufacturer in Asia & the best supplier of mesh belt type continuous furnace for heat-treatment of fasteners. San-Yung occupies 90% market share in Taiwanese fastener industry.

● www.sanyung.com
 ● tsy@sanyung.com
 三永電熱機械股份有限公司



SHEEN TZAR CO., LTD.

● Screw (Bolt) Formers, Self-drilling Screw Forming Machine, Cold Header, Thread Rolling Machine, Molds & Dies, Drill Point Dies, Self-drilling Dies, Automatic Thread Slotting Machine, Screw Washer Assembling Machine, Drilling Test Machine, Self Tapping Screw Point Cutting Machine, Heading Machine, Slotting Machine
 ● Sheen Tzar was founded in 1981, specialized in manufacturing and R & D of high speed self-drilling screw forming machines.

● www.sheentzar.com
 ● info@sheentzar.com
 新讚興業股份有限公司





_AD.[308]
SHENG LONG INDUSTRY

☉ Punch Pins, Carbide Pins, Punches, Square Punches, Hexagon Punches, Square Recess Punches, First Punch Dies, Header Punches, Hex Recess Punches, Multi-die Punches, Phillips Punches, Hexagon Pin Punches

☉ Your first choice for professional punch manufacturers. Professional Manufacturer of Punch Tools, The Quality is Second to None.

☉ www.slpunch.tw
☉ best.hogar@gmail.com
昇隆企業社



_AD.[345]
SHUN HSIN TA CORP.

☉ Square Punches, Hexagon Punches, Header Punches, Trimming Dies, Transfer Fingers ☉ In 1997, we established the Shun Hsin Ta Corp. The export services were promoted more actively. The continuous commitment of human resources, plant equipment and process technologies for the professional ability to meet customer demands. The development of the forming dies, punch tools to meet the product specifications and needs, and to provide customers with fast delivery.

☉ www.shun-hsin-ta.com
☉ chingta.chen@hibox.hinet.net
順興達股份有限公司



_AD.[355]
SUN FAME MANUFACTURING

☉ Cutter, Circular Saws, Electric Bench Grinders, Grinding Wheels, Electric Grinders, 6 Cuts/ 8 Cuts Self Drilling Screw, Automatic Thread Slotting Machine, Secondary product processing service

☉ Sun Fame has been established for over thirty-five years. Sun Fame strives to design and manufacture high quality Screw - Point - Cutting-Machines for fastener industry and we continue to innovate our design.

☉ www.screw-point-cutting-machine.com
☉ sales@screw-point-cutting-machine.com
商興業有限公司



_AD.[321]
TAIHO TOOL MFG. (OSG)

☉ Gauges, Others, Surface Treatment and Related Equipment, Diamond, CBN Tools and Cutters, Tungsten Carbide Tools and Cutters, Tapping Oil, Forming Taps, Nut Taps, Dies, Gauges, Drills, Endmills, Indexable (Face Mill, Shoulder Mill, Radius)

☉ Founded in 1938, OSG Corporation Japan has established 40 multinational companies over the years. The Corporation has been proud of being the leader in Cutting Tools Industry and declares OSG Groups to be a "global corporation" stepping into the 21st century.

☉ www.tosg.com.tw
大寶精密工具股份有限公司



_AD.[320]
TICHU INDUSTRIES

☉ Bi-metal Self-drilling Screws, Coil Nail Collator, Nut Tapping Machines, Self-drilling Screw Forming Machine, Tooling for Forming Machines, Thread Rolling Die Plates, Phillips Punches, Multi-station Cold Forming Machines, Thread Rolling Machines, Collated Screws, Bi-metal Screws

☉ K TICHU, founded in 1982, world-renowned professional manufacturer of Plastic Collated Screws, Bi-Metal Screws, Coil Nail Collators and Nail Rolling Machines.

☉ www.screw-nails.com.tw
☉ service@ticho.com.tw
帝潮實業有限公司



TSUNAMI LTD.

☉ Tooling For Forming Machines, Carbide Dies, Cutting Dies, Header Toolings, First Punch Dies, Second Header Punches, Taps Dies & Tools, Tungsten Carbide Dies, Trimming Dies Tungsten Carbide Forging Tools, Cutting Blades and Cutting Dies for Screws, Bolts, Nuts or Bicycle Parts

☉ Our product are widely used in heading and multi-station machines to make screws, nuts, automobile parts, bicycle parts and other related parts.

☉ www.tsunami-p.com.tw
☉ shuantai.trade@gmail.com
宣大企業有限公司





_AD.[347]
TUNG FANG ACCURACY

☉ Carbide Pins, Carbide Dies, Polygon R-type Punches, Square Punches, Hexagon Punches, First Punch Dies, Cutting Dies, Second Punch Cases, Lobe Punches, 12-Point Punches, Carbide Punches, Special Punches, Screw Dies ☉ Tung Fang was established in 1995, specializing in producing and processing casting dies and parts. The factory is in Taiwan. Tung Fang holds "Continuous R&D To Reach Excelsior" as its business principle and provides service in a reliable attitude.

☉ www.punch-die.com
☉ tfa_6970693@yahoo.com.tw
東鈺精密股份有限公司



TZE PING PRECISION MACHINERY

☉ Open Die Re-Header, Used Machinery, Separation Systems ☉ Tze Ping Precision Machinery Co., Ltd. was established in 2004, is a professional manufacturer of open die re-header. Besides patents, all machines also conform to CE standards to ensure the stability of production quality. Our machinery has four product features, including material-saving, low cost molds, shortened processing time, and products with no length limit.

☉ www.tze-ping.com
☉ tpp.machine@msa.hinet.net
智品精密機械有限公司



_AD.[351]
UTA AUTO INDUSTRIAL

☉ Rubber Washers, Bonded Washers, Screw & Nylon Anchor Assembly Machines, Screw Washer Assembling Machines, Blind Rivet Assembly Machines, Drive Pin & Washer Assembly Machine, Rubber-to-metal Anti-vibration Sealing Washers, Cable Clip & Nail Assembly Machines, Long Self-Drilling / Tapping Screw & Washer Assembly Machines, Nail & Metal Anchor Assembly Machines, Sealing Washers, External Tooth Washers

☉ UTA was originally founded in 1980.

☉ www.uta.com.tw
☉ utaauto@uta.com.tw
有達工業股份有限公司

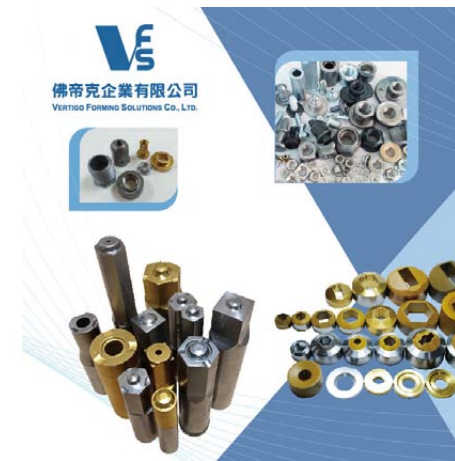

_AD.[293]
VERTIGO FORMING SOLUTIONS

☉ Punches, Slot Punches, Segmented Hexagon Dies, Trimming Dies, Square Nuts, Special Nuts ☉ Vertigo Forming Solutions Co., Ltd. with a strong development and management team that has over two decades of professional experience in cold forging tools and fasteners field, is a reliable team you can count on. In the field of cold forging tools, we can support a wide range of tools, from high-end customized tools to irregular fastener tools to our customers.

☉ www.vertigoformingsolutions.com
☉ vfs.amychang@gmail.com
佛帝克企業有限公司



_AD.[360]
WAN IUAN ENTERPRISE

☉ Carbide Pins, Tooling For Forming Machines, Carbide Dies, Polygon R-type Punches, Square Punches, Hexagon Punches, Trimming Dies, Square Recess Punches, Hex Recess Punches, Hexagon Pin Punches, Punch Pins ☉ Wan Iuan Enterprise Co., Ltd. was established in 1991 in Taiwan. We have CNC turning and machining experience in the fastener tooling filed. We are the manufacturer of irregular and customized punches and dies for screws and special nuts.

☉ www.w-i.com.tw
☉ sales@w-i.com.tw
萬淵企業股份有限公司

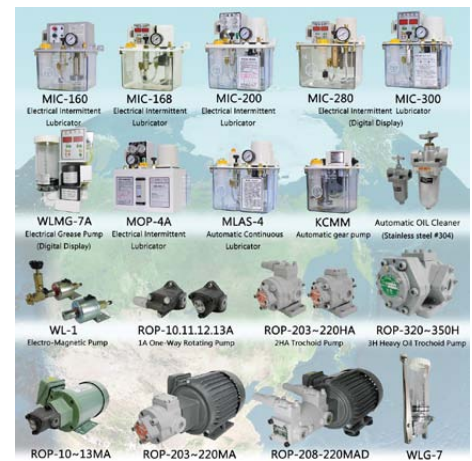

_AD.[359]
WEI LIANG CORPORATION

☉ Customized and Optimal Centralized Lubrication Systems, Air and Hydraulic Equipment, and Pipe Fitting Accessories, Electrical Intermittent Lubricator, Automatic Continuous Lubricator, Automatic Gear Pump, Automatic Oil Cleaner

☉ If you have any comments or inquiry, please don't hesitate to Contact us at your early convenience and we will hold ourself at the best and satisfaction.

☉ www.zenloon.com.tw
☉ peja741017@gmail.com
維良企業股份有限公司





_AD.[312]

WEN YANG (MING TANG)

☉ Heading Machines, Open Die Machines, Parts Forming Machines, Screw Washer Assembling Machines, Fastener Makers, Screw (Bolt) Formers, Filling Feeders, Thread Rolling Machines ☉ Our company was founded in 1979, specialized in manufacturing all kinds of bolt parts formers. Because we insist on "quality first", and "continuous research and development", of the two major policies, so that enables our products to be recognized by each customer.

☉ www.mingtang.com.tw
☉ wenyang@mingtang.com.tw
玟錫機械有限公司



_AD.[444]

YESWIN MACHINERY

☉ Screw (Bolt) Formers, Fastener Makers, Multi-station Cold Forming Machines, Nut Formers, Heading Machines, Parts Forming Machine, Cold Headers, Sockets Formers ☉ Yeswin Machinery manufactures multi-station cold forging machines. We provide bolt formers with 3 die 3 blow, up to 7 die 7 blow models, covering sizes from M3 up to M30. Yeswin follows CEO Mr. Chu's concept of management - friendship, quality, service, and sincerity - to run the business.

☉ www.twyeswin.com
☉ yeswin@twyeswin.com
友信機械股份有限公司



_AD.[348]

YI SHENG MACHINERY

☉ Self-drilling Screw Forming Machines ☉ We are Yi Sheng Machinery Co., Ltd, a specialized manufacturer of self-drilling screw forming machines in Taiwan. We are promoting self-drilling screw forming machines and related mechanical parts. If you don't mind, we are very glad to share more information with you. If you would like further information, please don't hesitate to contact us through email.

☉ yi-sheng.weebly.com
☉ a0923243033@gmail.com
鎰晟機械有限公司



_AD.[338]

YI TI MOLD ENTERPRISE

☉ Cold Heading Forming Toolings, Like Header Punches, Hexagon Punches, Trimming Dies, K. O. Pins, Heading Dies, Nut Forming Dies, Thread Rolling Dies, Self Drilling Pointing Dies, Grippers / Fingers and Special Parts for Customization

☉ Yi Ti Mold was established in 2003. Our worldwide customers include Argentina, Australia, Brazil, Bulgaria, Croatia, Germany, Italy, India, Iran, New Zealand, Netherlands, Poland, Portugal, Turkey, Thailand, U.A.E, U.S.A...etc.

☉ www.yitimold.com.tw
☉ info@yitimold.com.tw
煜鈦企業有限公司

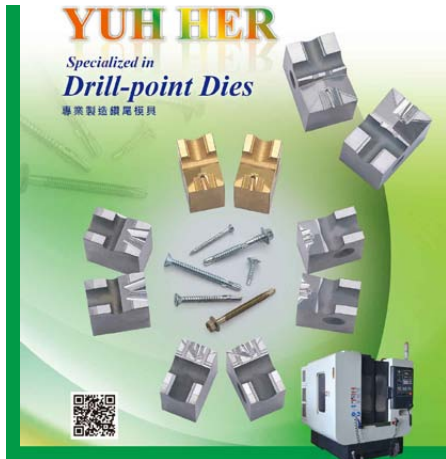

_AD.[329]

YUH HER PRECISION

☉ Pointing Dies, Self-drilling Dies ☉ Specialized in Drill-point Dies

☉ www.fastener-world.com/en/supplier/yuhher
☉ yuhoellc@gmail.com
育和精密有限公司



_AD.[349]

ZEN-YOUNG INDUSTRIAL

☉ Screw & Nylon Anchor Assembly Machine, Screw Washer Assembling Machine, Blind Rivet Assembly Machine, Drive Pin & Washer Assembly Machine, Cable Clip & Nail Assembly Machine, Long Self - Drilling / Tapping Screw & Washer Assembly Machine, Fastener Maker, Nail & Metal Anchor Assembly Machine, Stainless Steel Cap & Self - Drilling / Tapping Screw Assembly Machine, Collated Strip Pin Assembly Machine, Collated Screws

☉ www.zen-young.com.tw
☉ zenyoung@ms72.hinet.net
仁陽工業股份有限公司

